

Serie Remo

Soft close hoekinstap

Montage Voorschrift

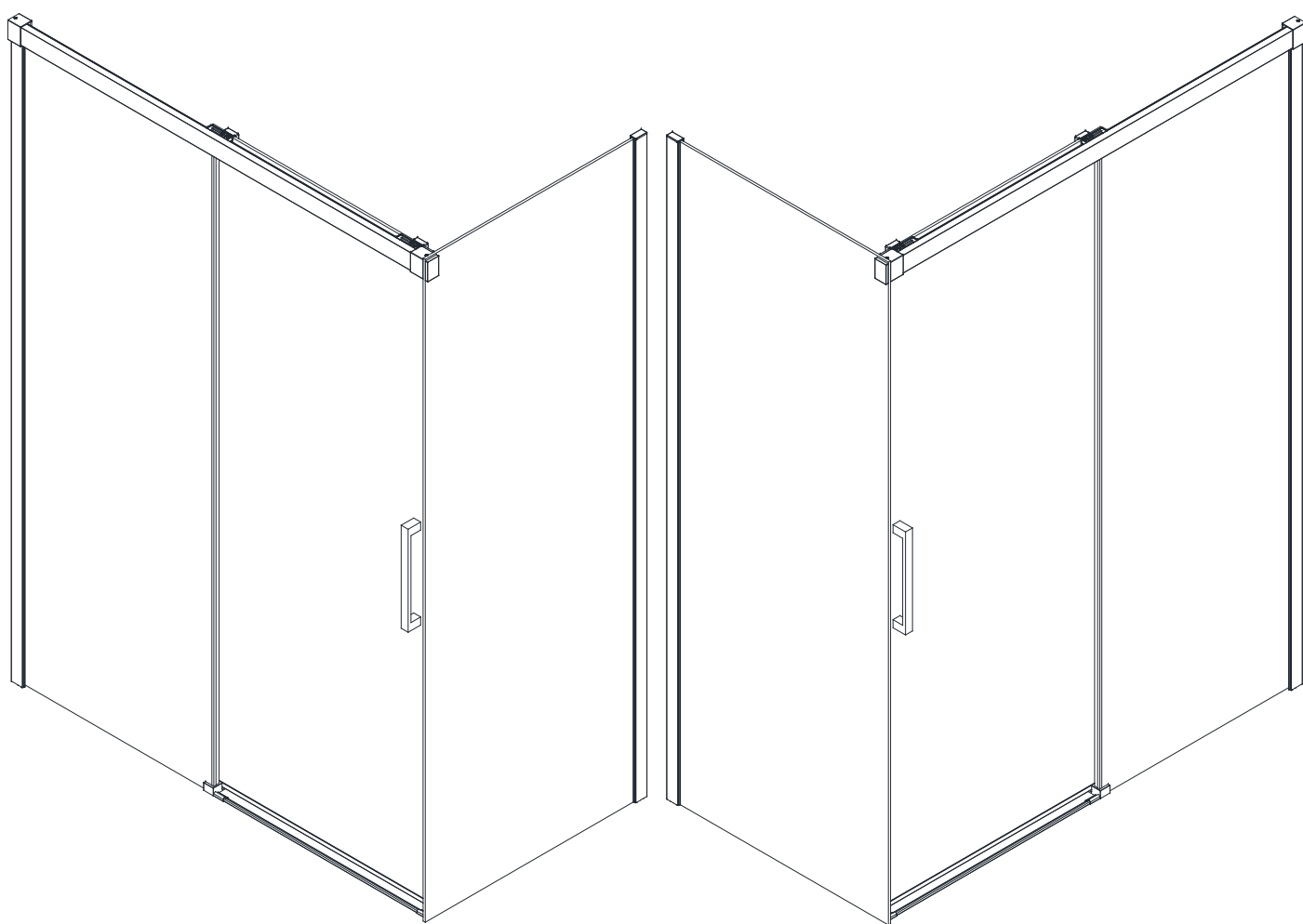

Deze douchewand is behandeld met een NANO-FLOW antikalkbehandeling

HANDLEIDING

Lees deze handleiding goed door voor u met de installatie begint.

1. Overtuig u ervan dat u het benodigde gereedschap heeft
2. Controleer dat de plaats voor installatie geschikt is voor de MAATVOERING
3. Controleer alle onderdelen van de douchecabine
4. Overtuig u ervan dat de montageset compleet is
5. Controleer indien de cabine op een douchebak komt, dat deze aan alle zijden waterpas staat, En dat deze voor installatie aan de muurzijden volledig en goed is afgekit

Indien er onderdelen beschadigd zijn of ontbreken, dient u uw leverancier binnen 2 dagen na de datum van aankoop daarvan in kennis te stellen. Probeer NIET het artikel te installeren zonder eerst de hierboven aangegeven 5 punten in acht te hebben genomen **NA INSTALLATIE KUNT U NIET MEER RECLAMEREN**

De muurpluggen die met de montageset meegeleverd worden, mogen alleen op stevige wanden gebruikt worden. Bij "scheidingswanden" dient u een ander bevestigingsmethode toe te passen. Wendt u tot een ijzerhandel voor verdere informatie over de juiste bevestigingsmethode. Soms is het voor de juiste boormethode noodzakelijk het advies van een tegelhandel in te winnen.

LET OP! Gebruik altijd roestvrijstalen schroeven.

BENODIGDHEDEN

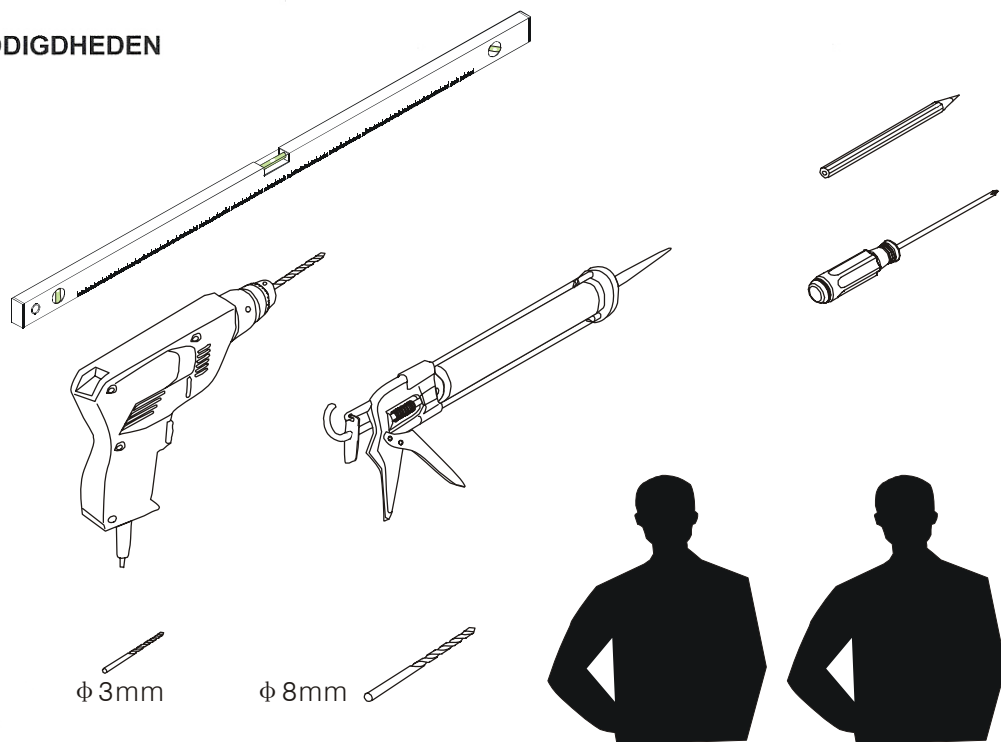

BELANGRIJKE INSTRUCTIES VOOR DE KLANT

Voor het schoonmaken van uw douchecabine moet u alleen een zachte doek gebruiken. Gebruik nooit oplos-, was-, en schuurmiddelen, omdat deze de glanzende chroomlaag zouden kunnen beschadigen.

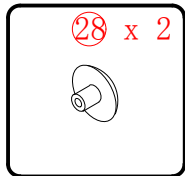
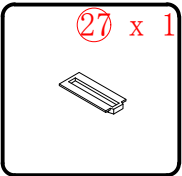
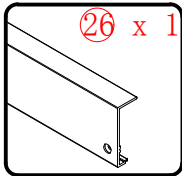
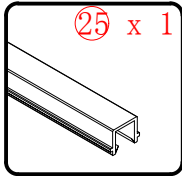
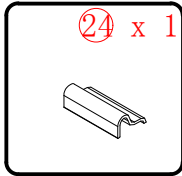
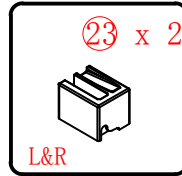
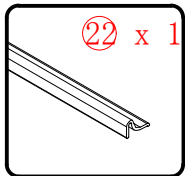
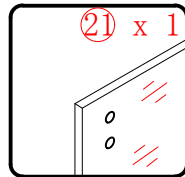
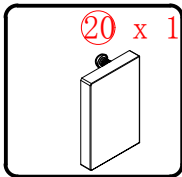
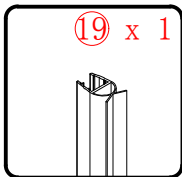
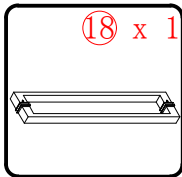
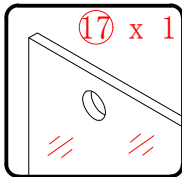
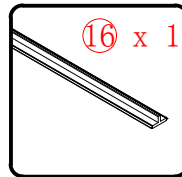
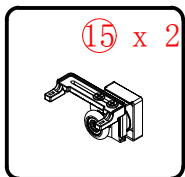
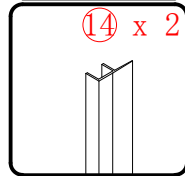
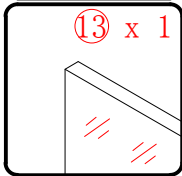
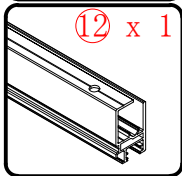
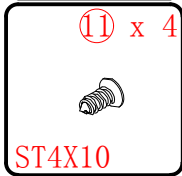
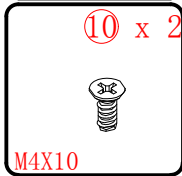
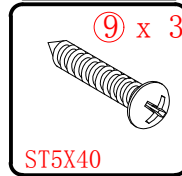
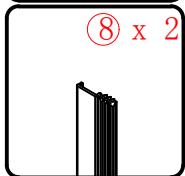
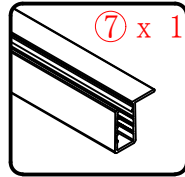
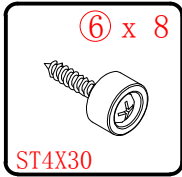
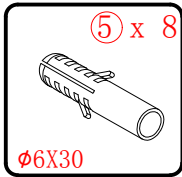
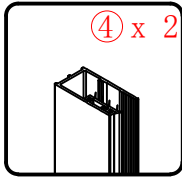
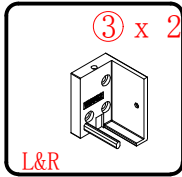
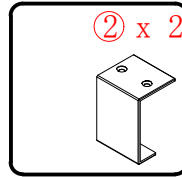
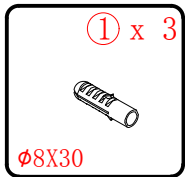
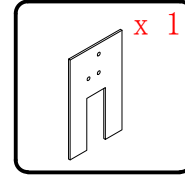
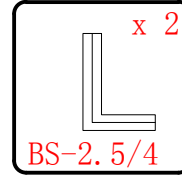
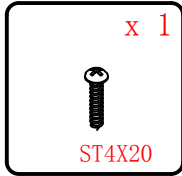
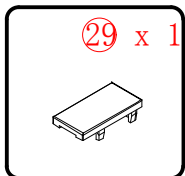
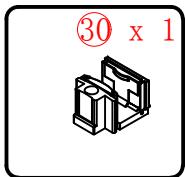
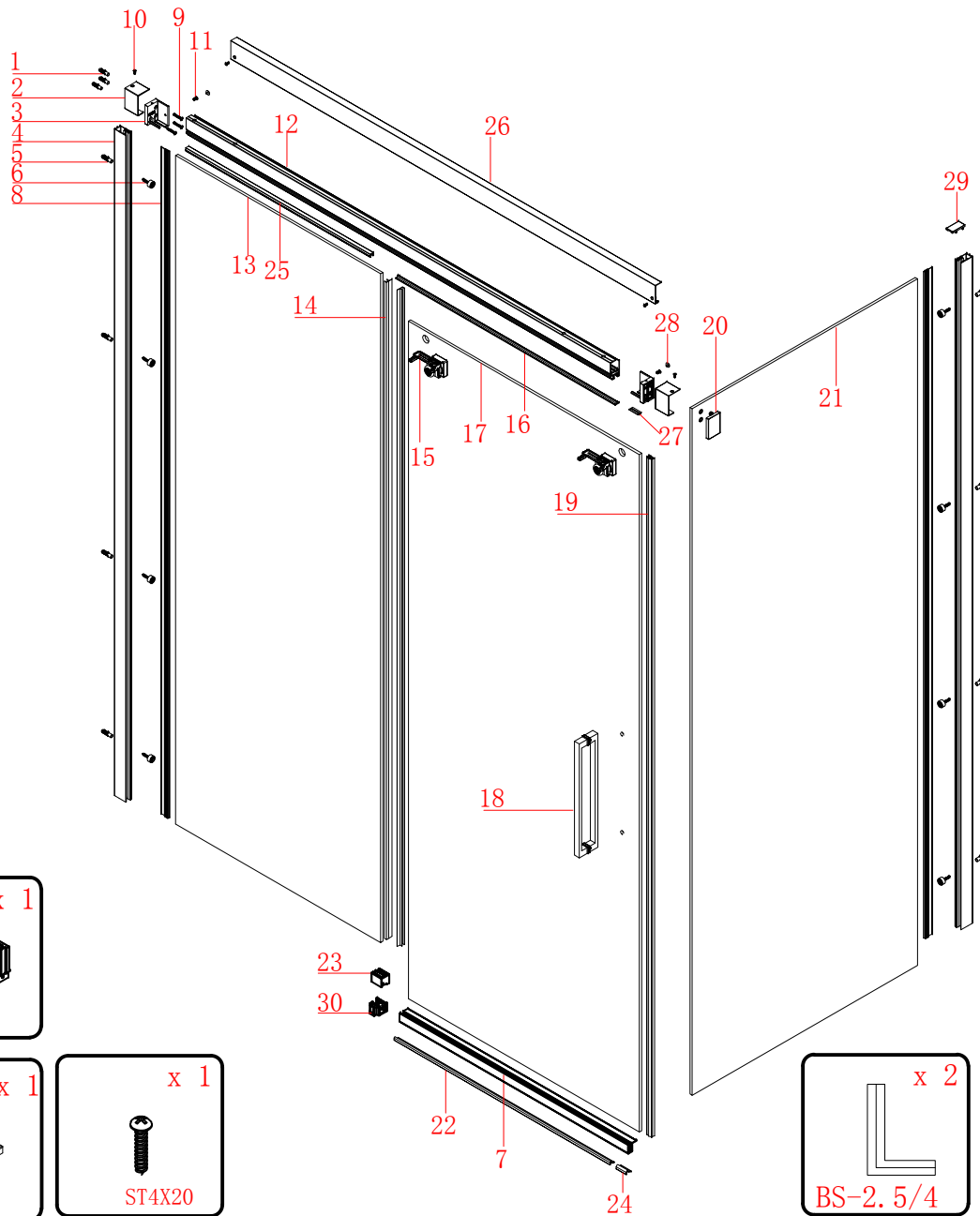

"Dit product is zwaar en vereist 2 personen voor installatie"



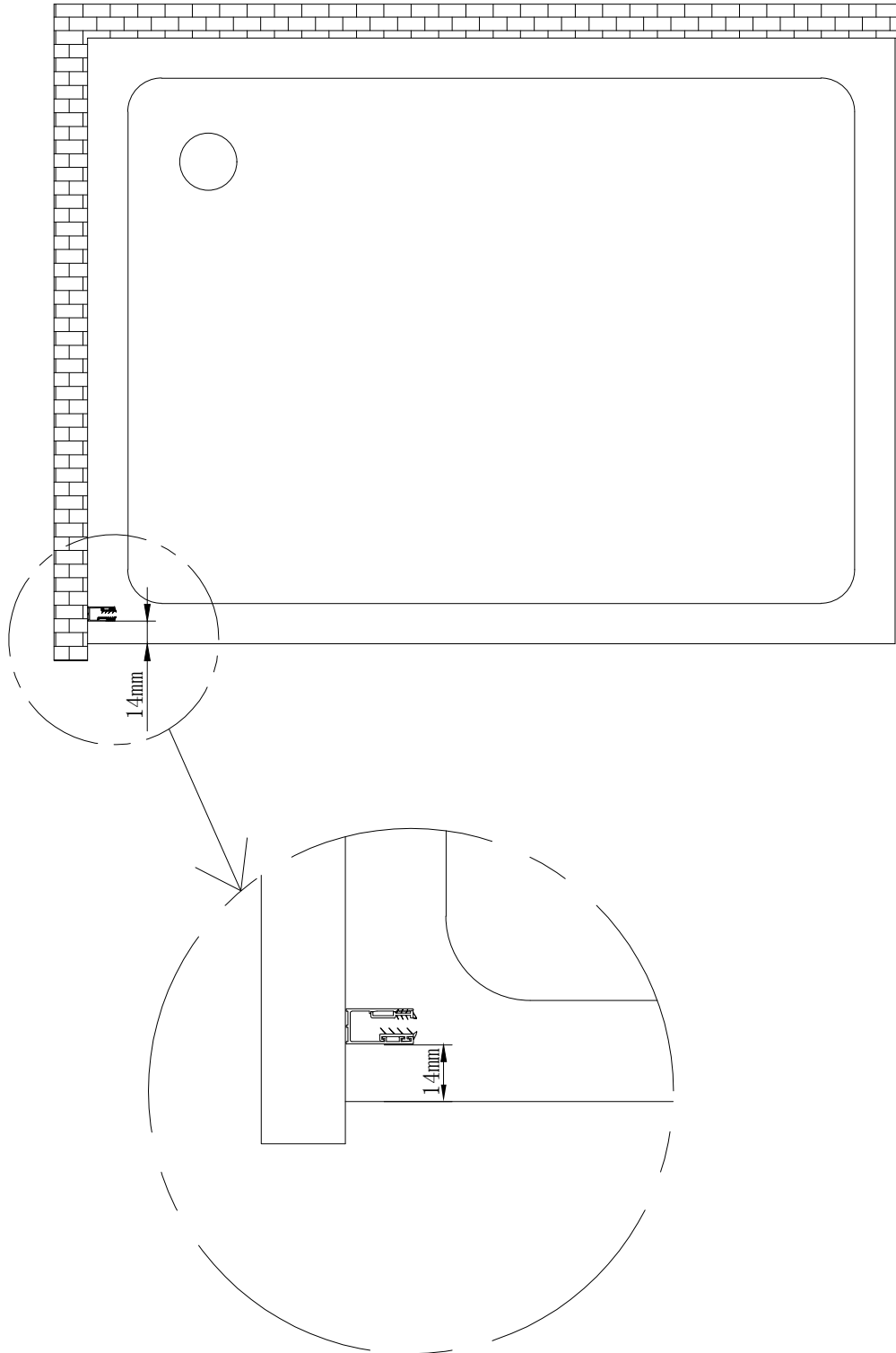

douchebakmontage



"Dit product is zwaar en vereist 2 personen voor installatie"



OF

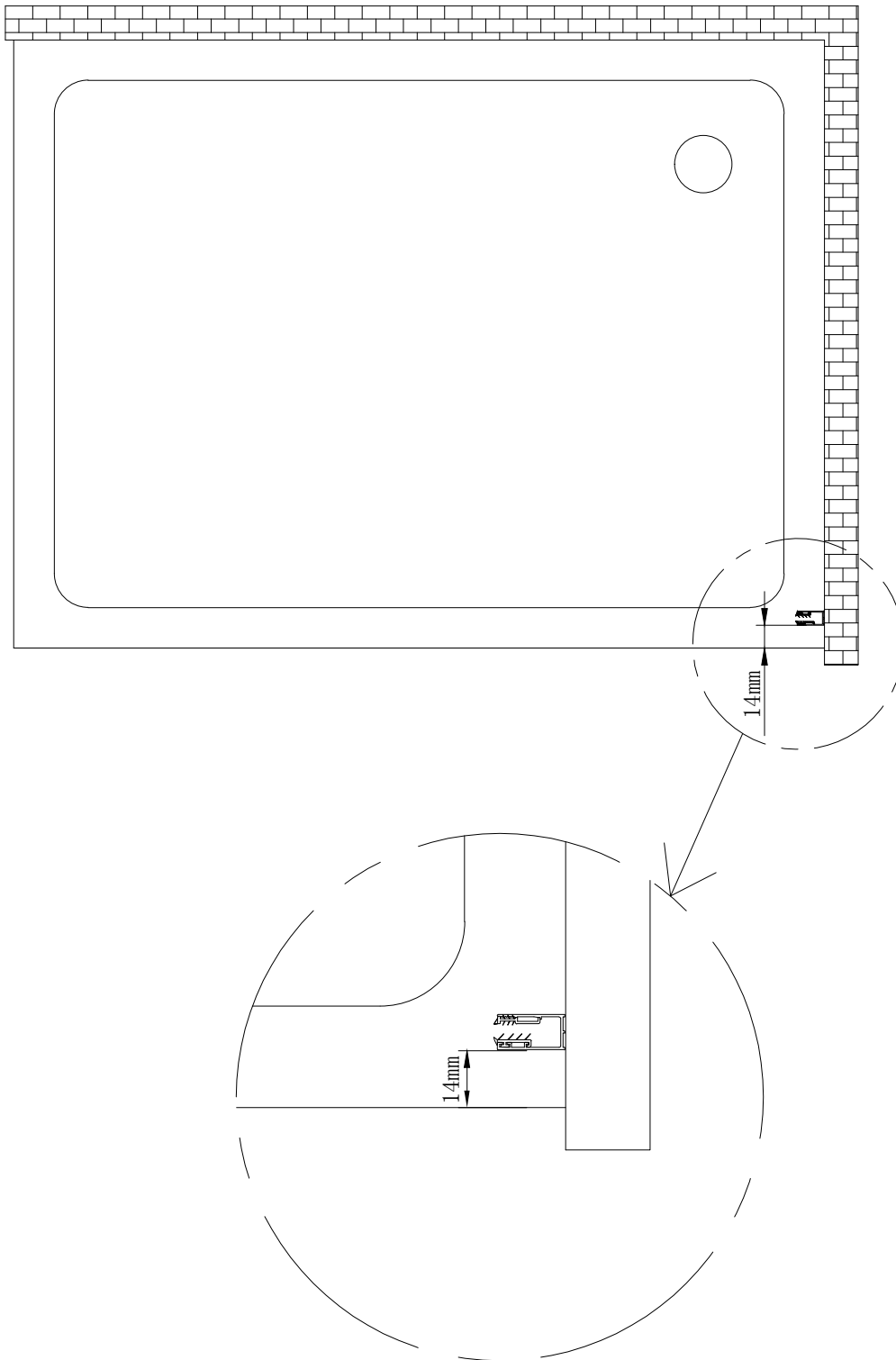

douchebakmontage



"Dit product is zwaar en vereist 2 personen voor installatie"



571-591/
671-691/
771-791/
871-891/
971-991

984-1014/
1184-1214/
1384-1414/
1584-1614

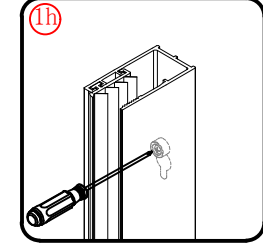
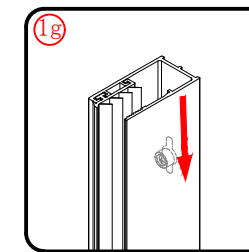
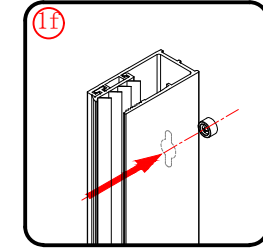
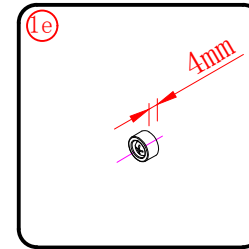
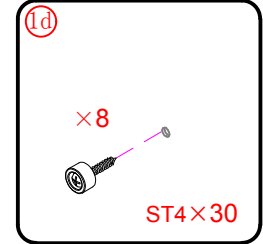
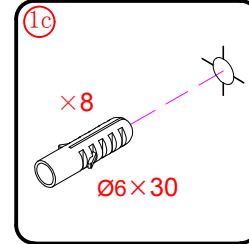
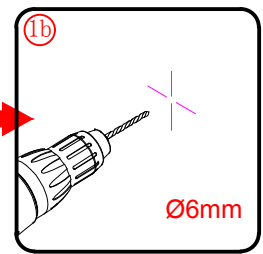
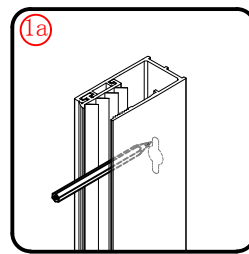
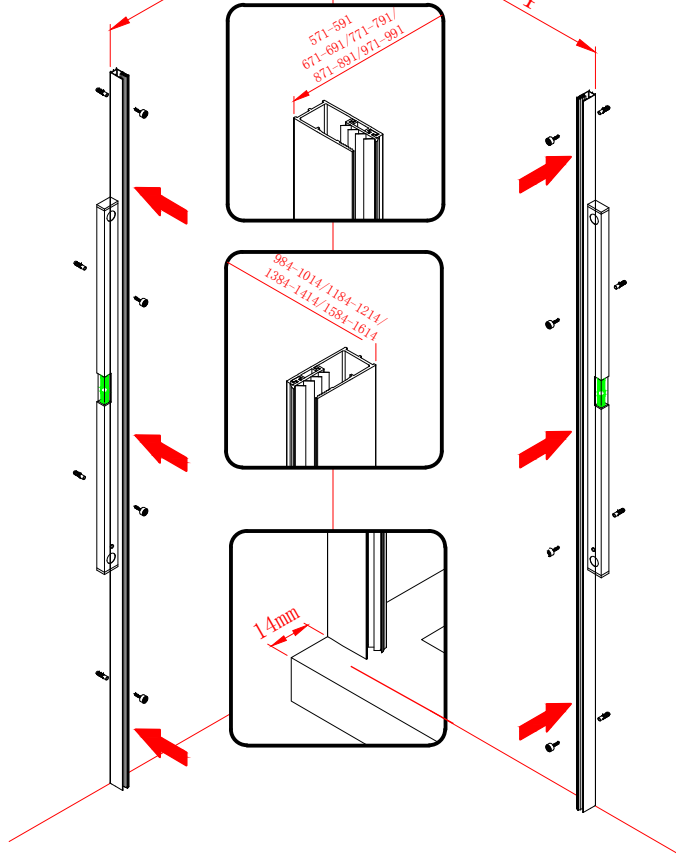

3

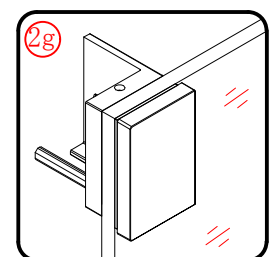
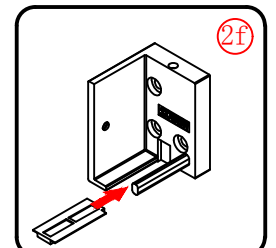
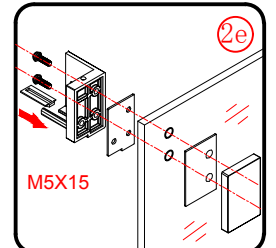
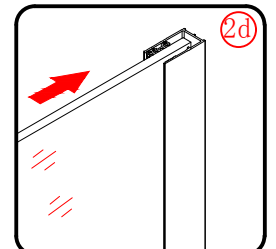
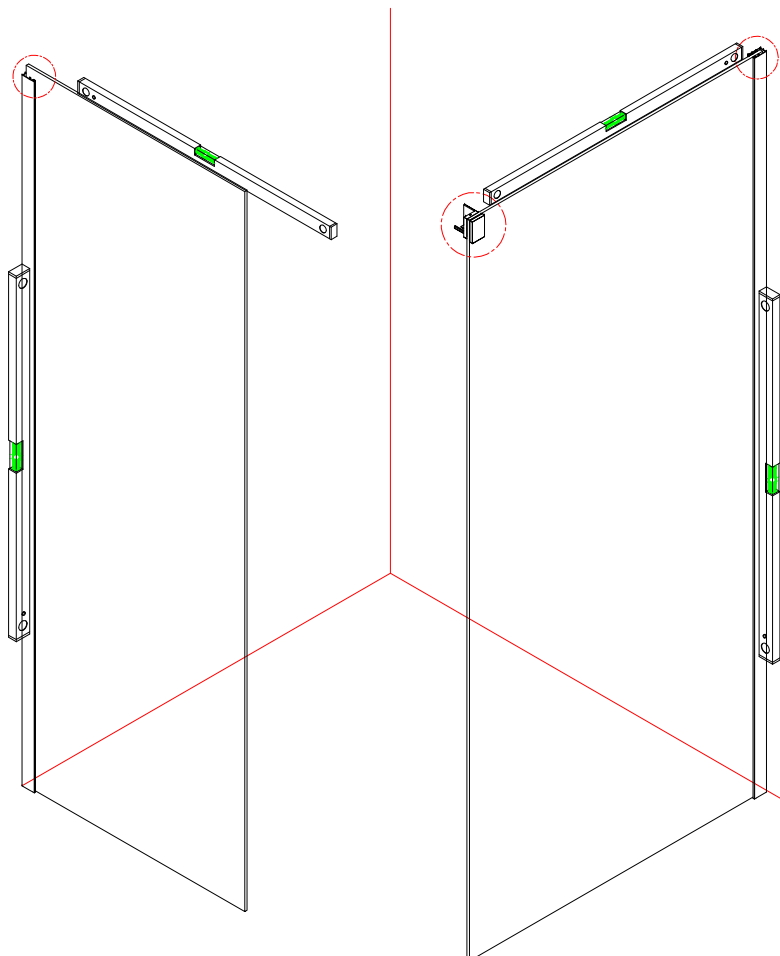
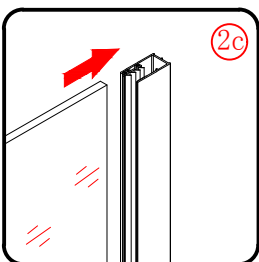
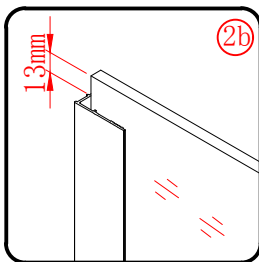
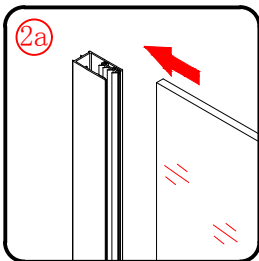

"Dit product is zwaar en vereist 2 personen voor installatie"



OF

984-1014/
1184-1214/
1384-1414/
1584-1614

571-591/
671-691/
771-791/
871-891/
971-991

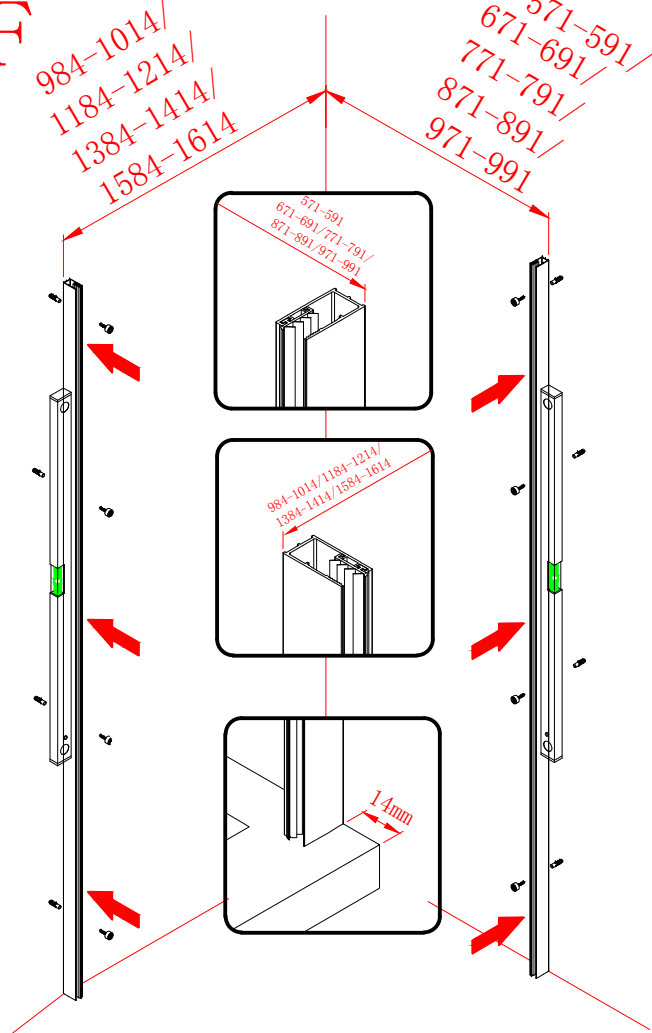
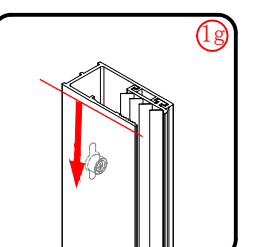
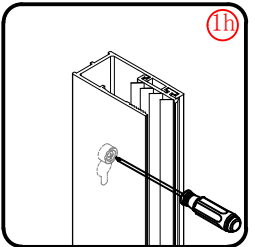
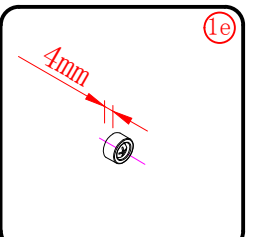
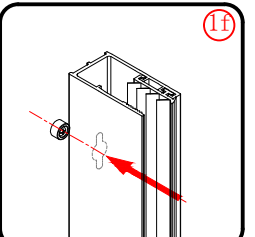
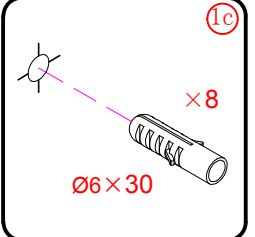
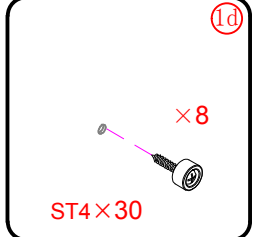
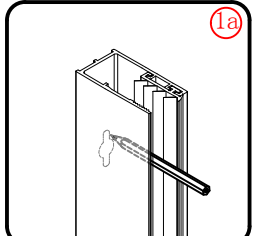
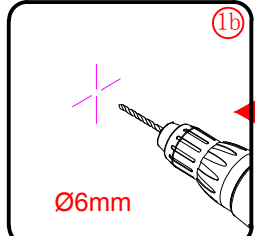

3

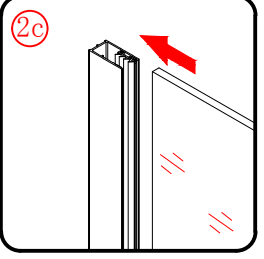
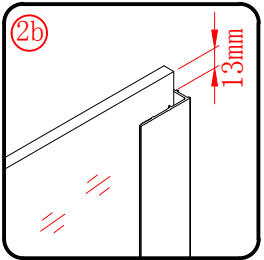
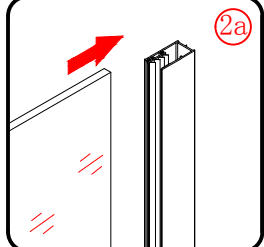
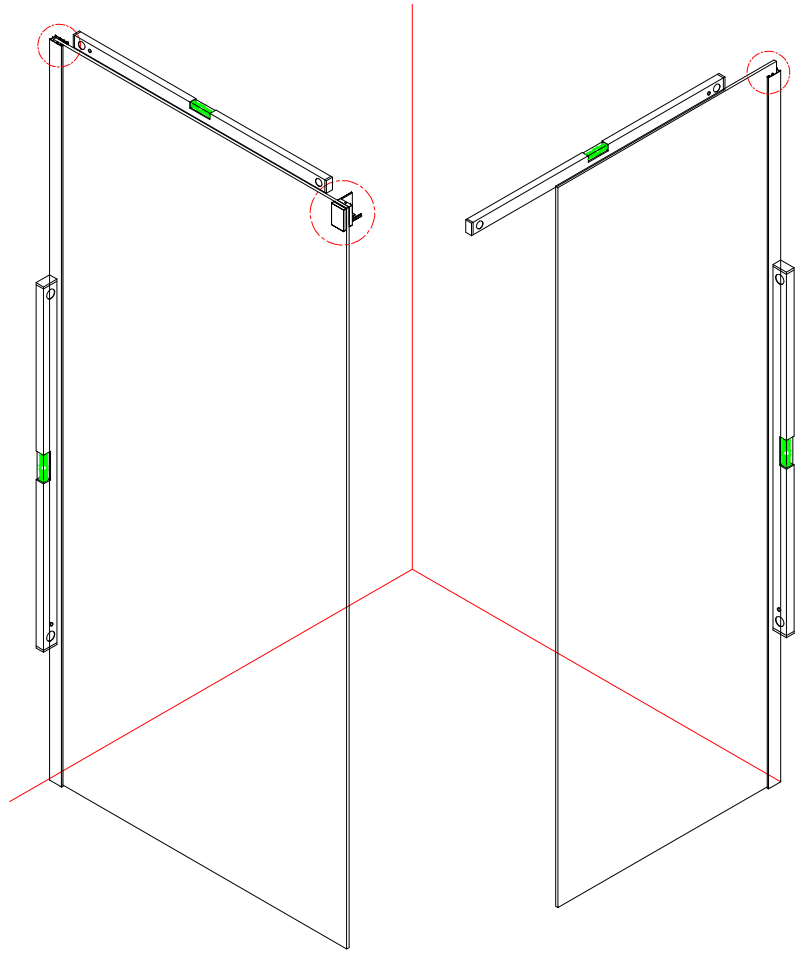
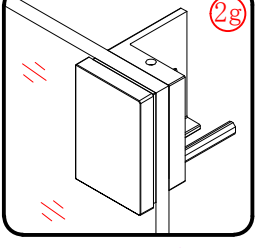
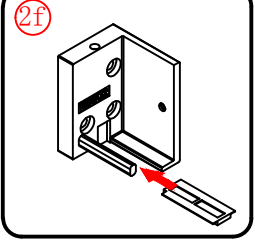
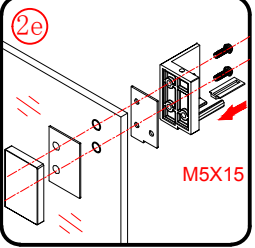
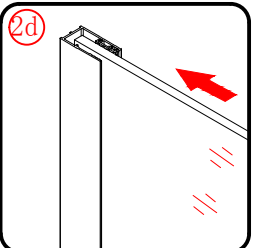

"Dit product is zwaar en vereist 2 personen voor installatie"



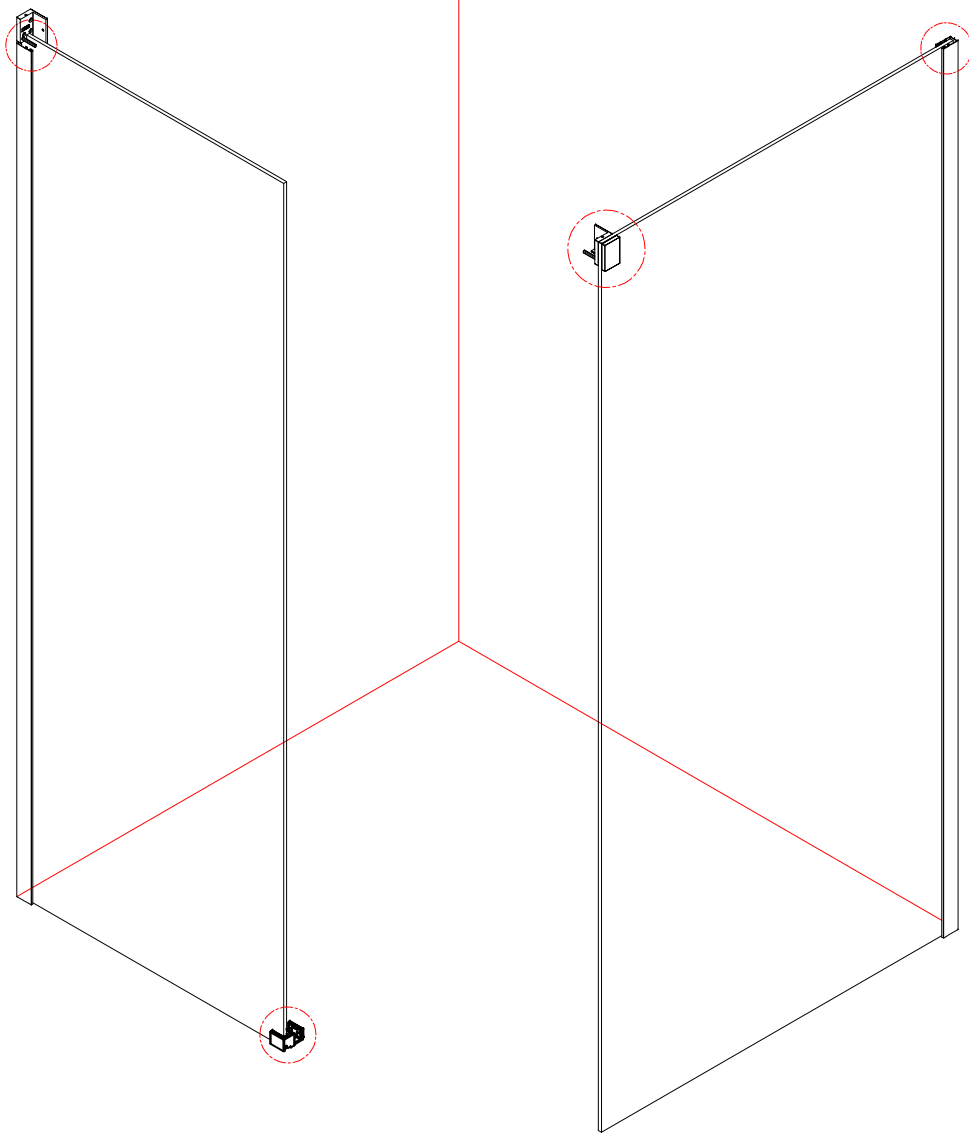
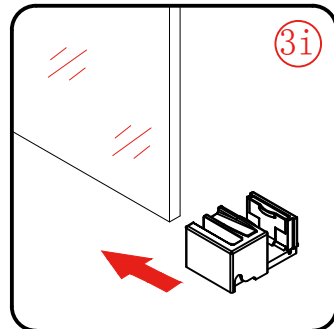
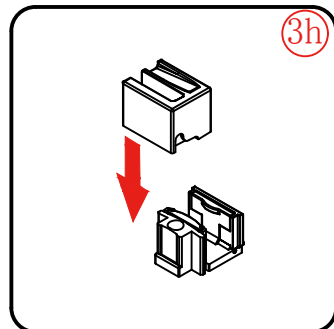
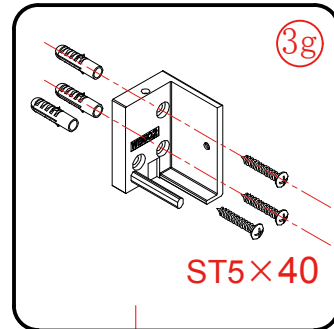
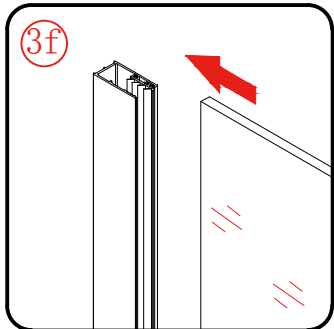
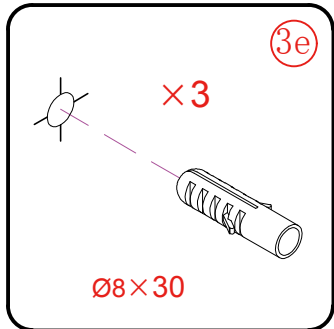
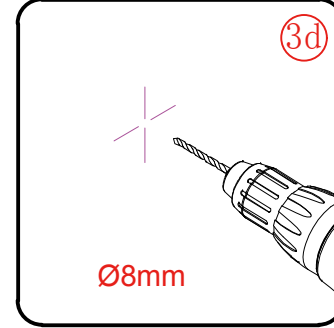
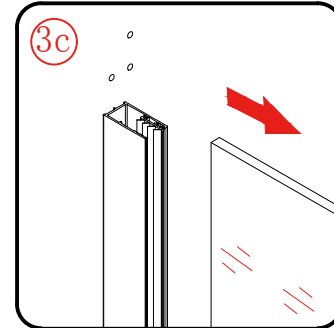
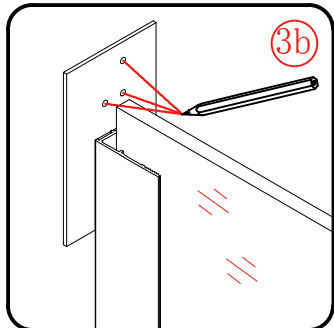
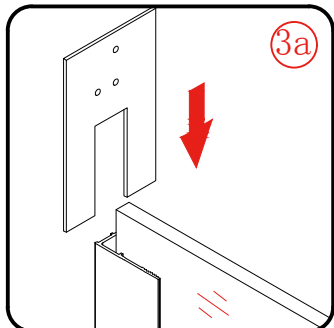

"Dit product is zwaar en vereist 2 personen voor installatie"



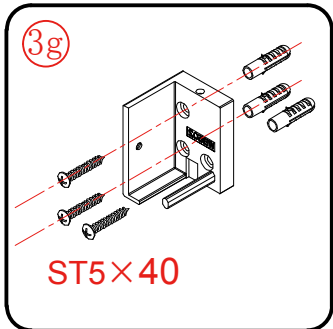
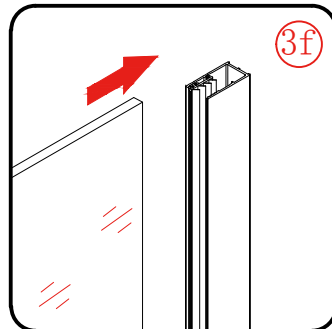
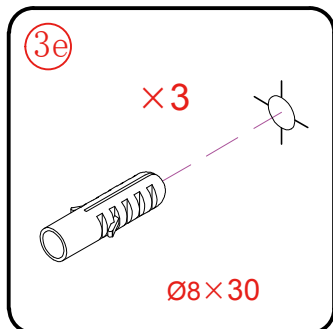
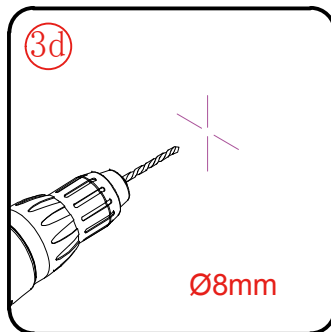
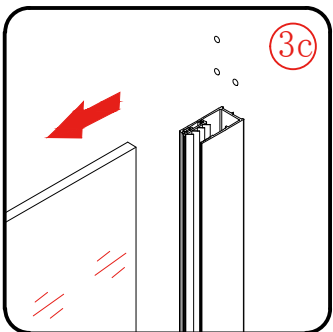
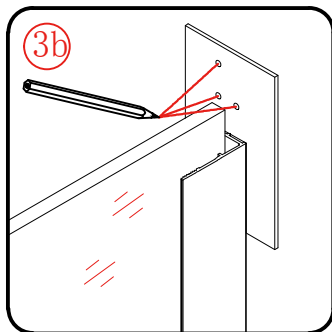
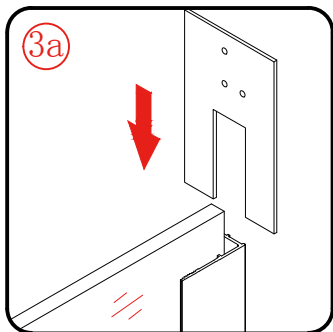

OF

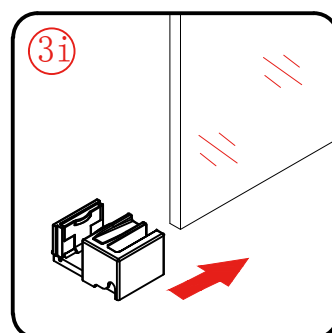
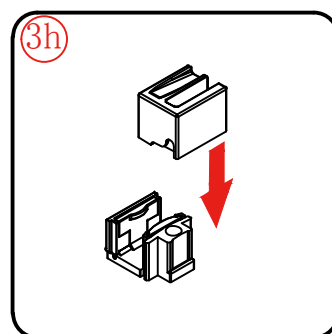
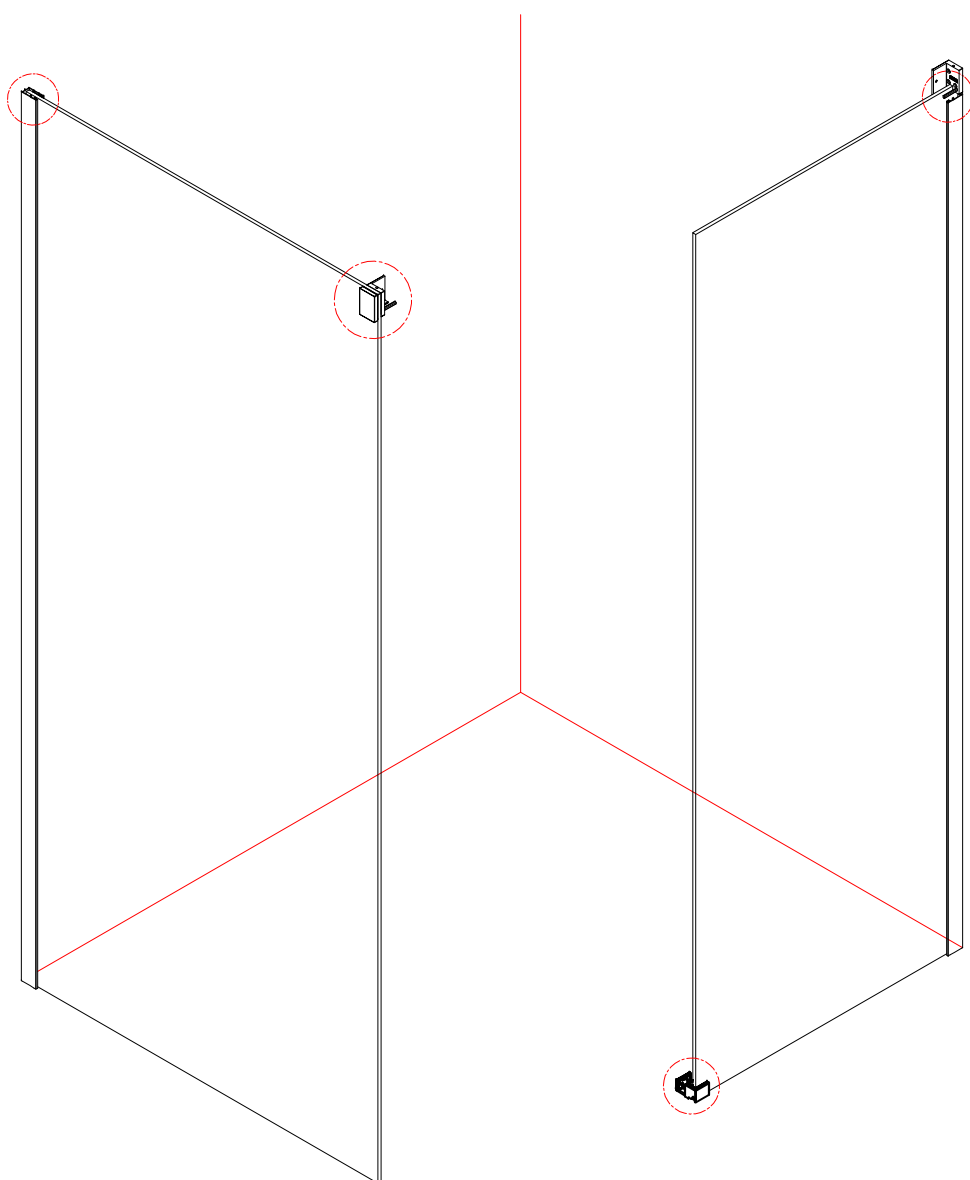

"Dit product is zwaar en vereist 2 personen voor installatie"



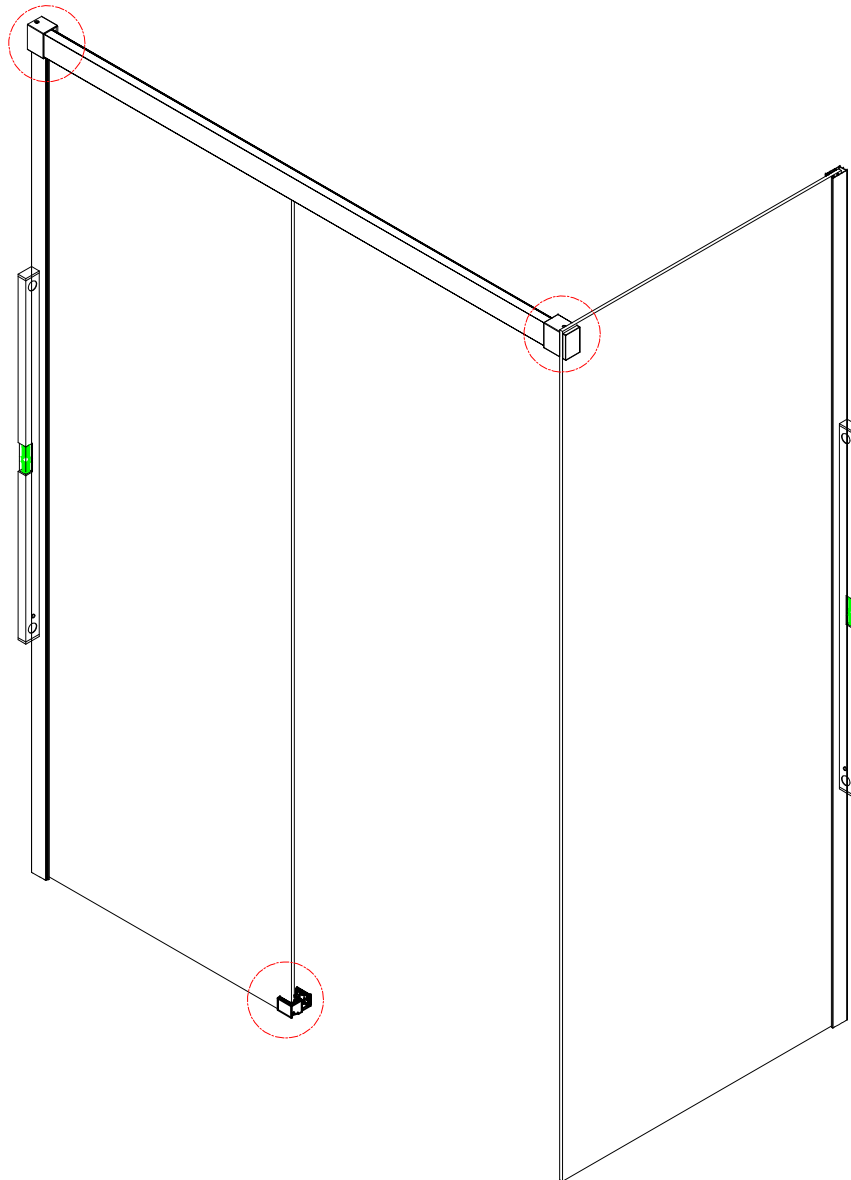
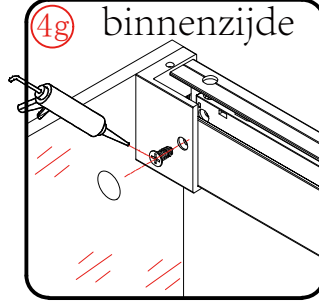
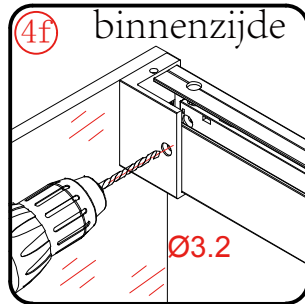
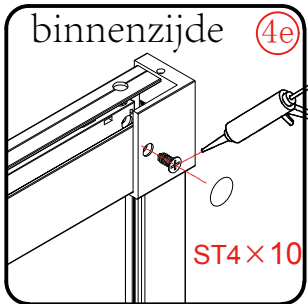
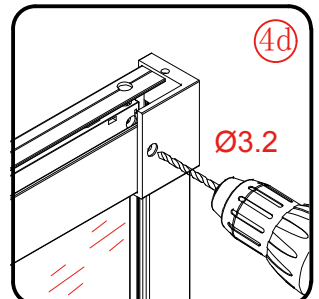
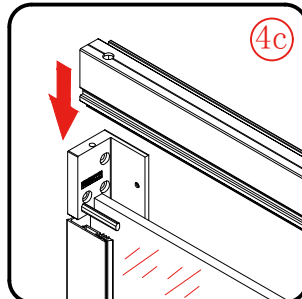
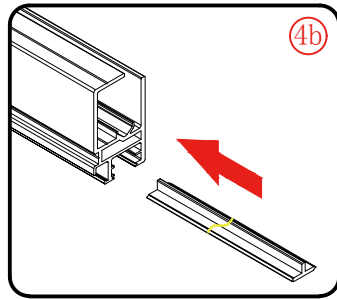
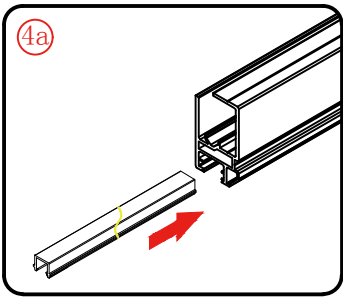

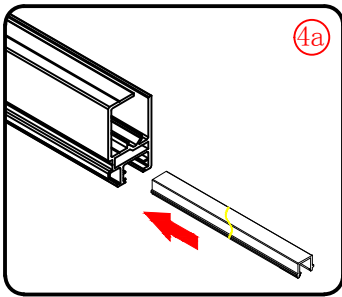

4a

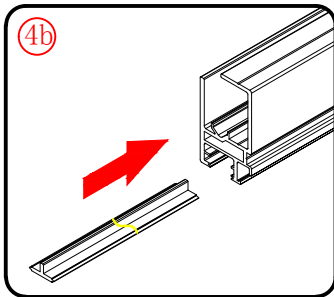

4b

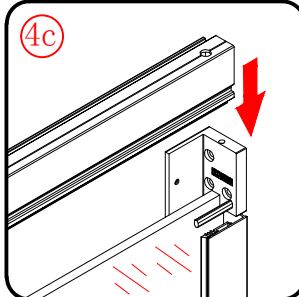

4c

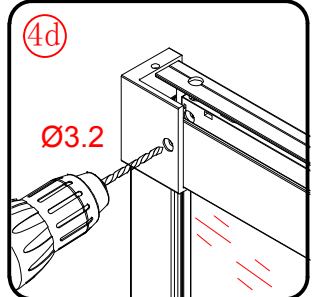

4d

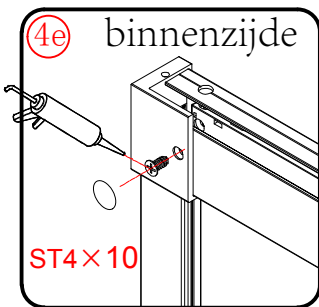

4e

binnenzijde

ST4x10

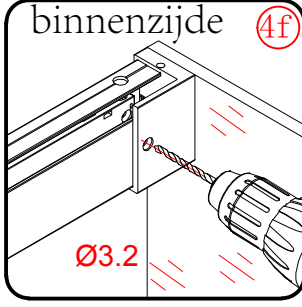

binnenzijde

4f

Ø3.2

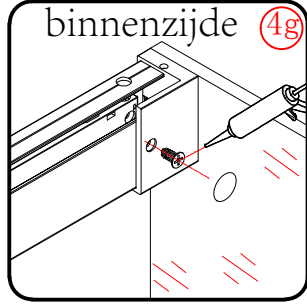

binnenzijde

4g

OF

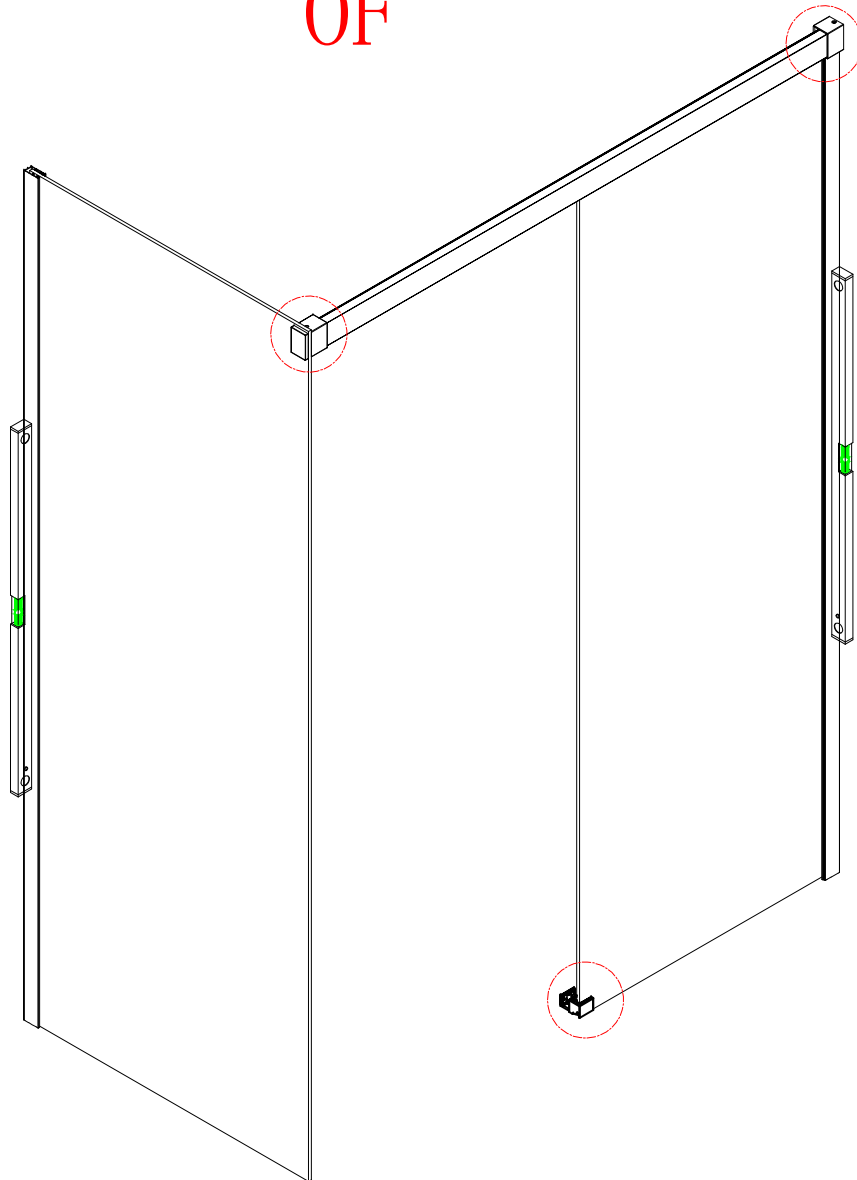

5



"Dit product is zwaar en vereist 2 personen voor installatie"



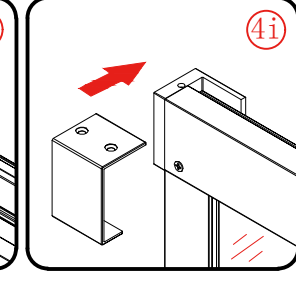
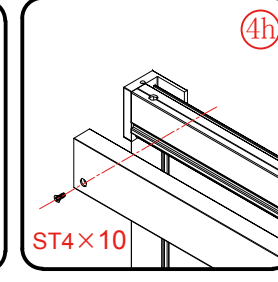
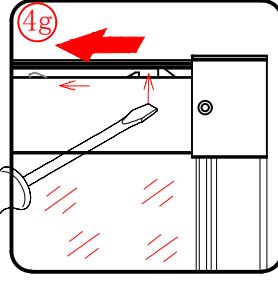
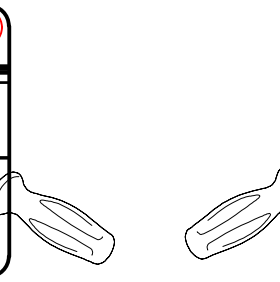
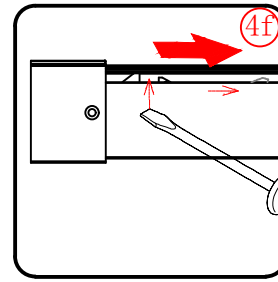
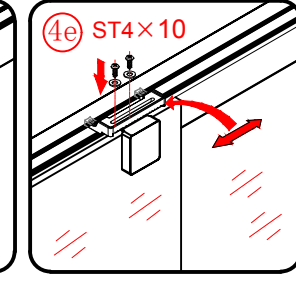
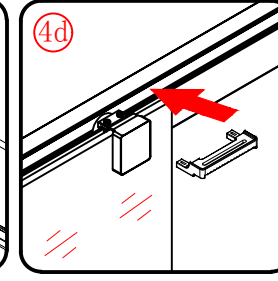
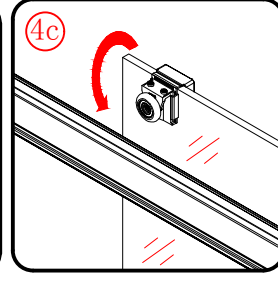
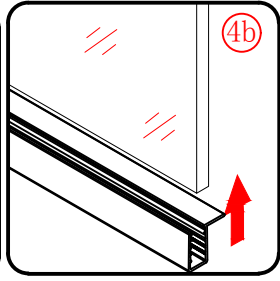
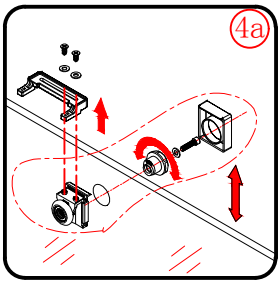

Activeer de softclose dempers voor gebruik. Zie afbeelding

Activeer de softclose dempers voor gebruik. Zie afbeelding

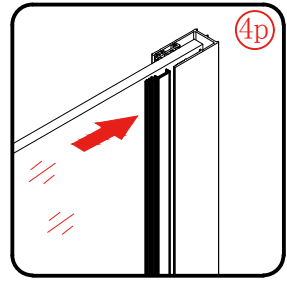
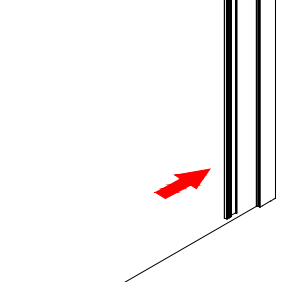
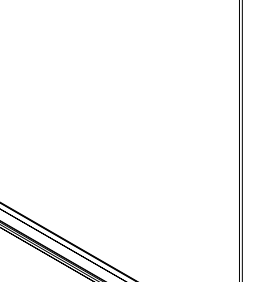
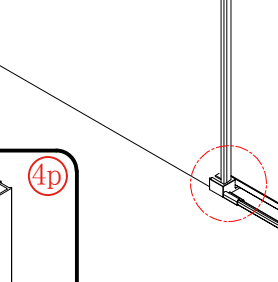
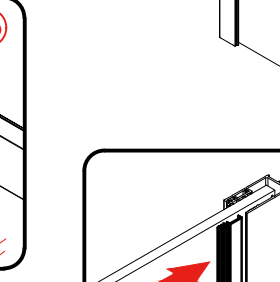
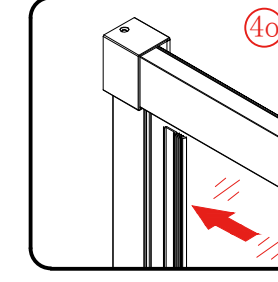
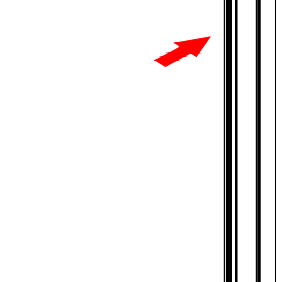
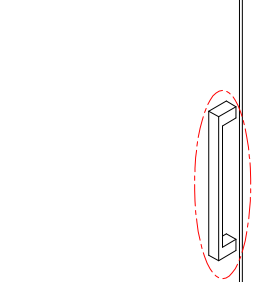
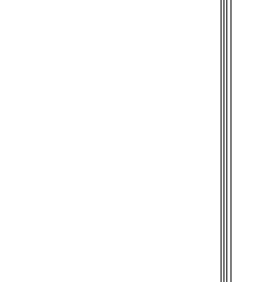
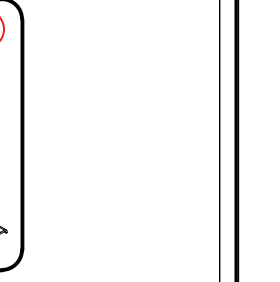
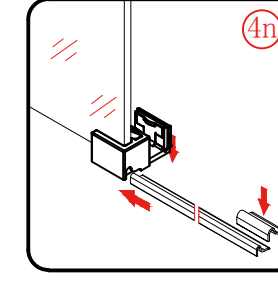
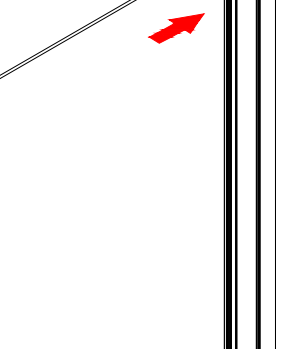
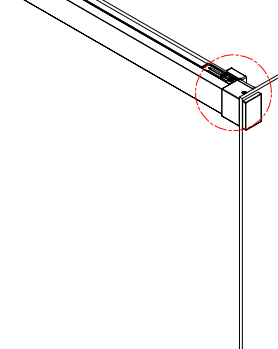
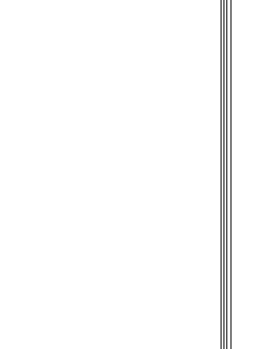
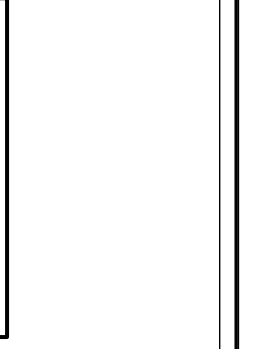
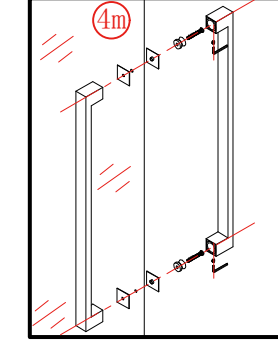
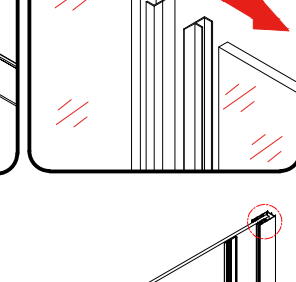
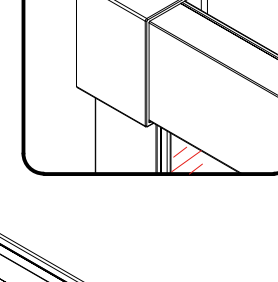
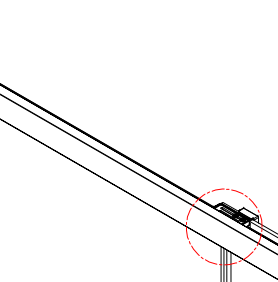
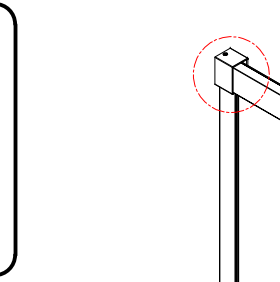
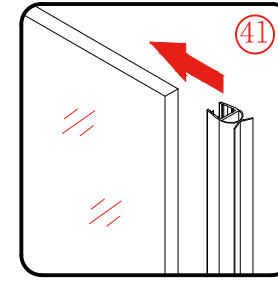

"Dit product is zwaar en vereist 2 personen voor installatie"



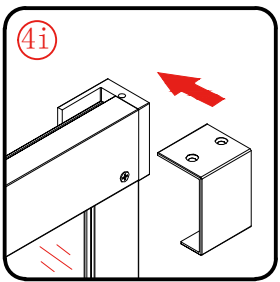
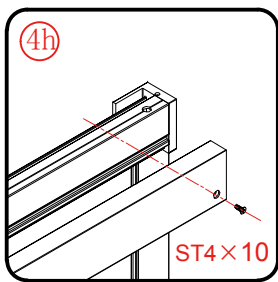
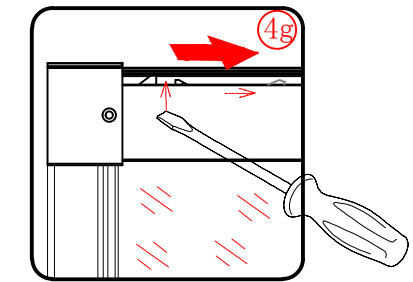
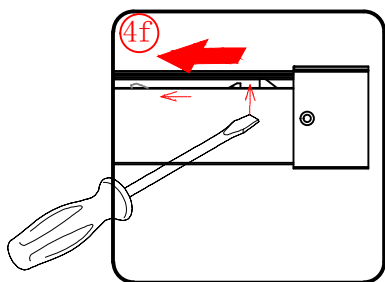
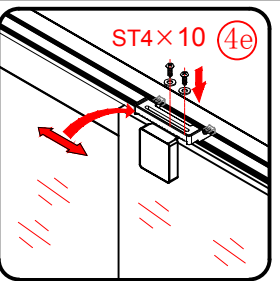
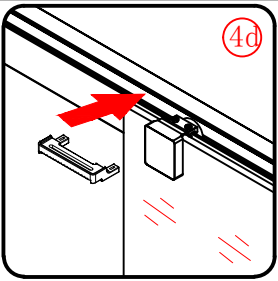
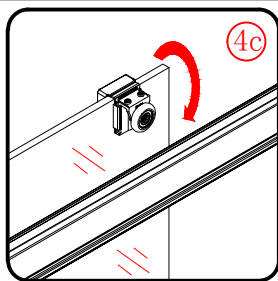
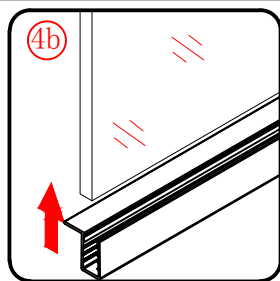
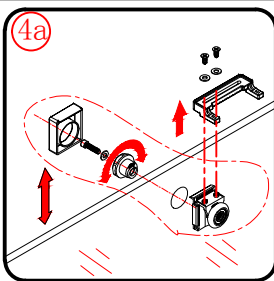

Activeer de softclose dempers voor gebruik. Zie afbeelding

Activeer de softclose dempers voor gebruik. Zie afbeelding

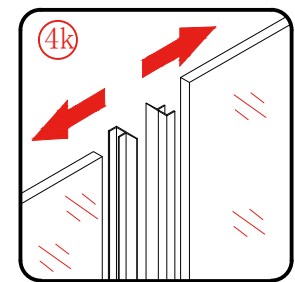
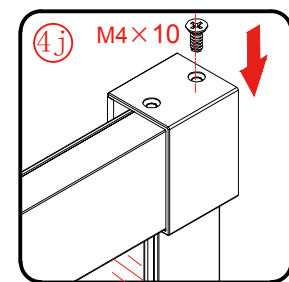

OF

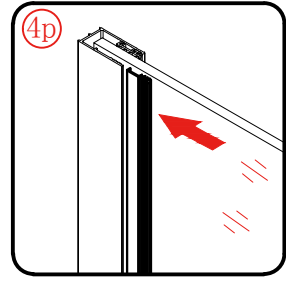
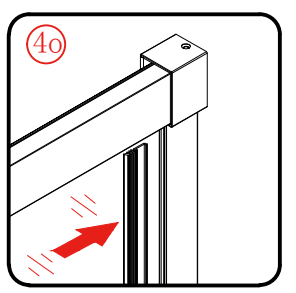
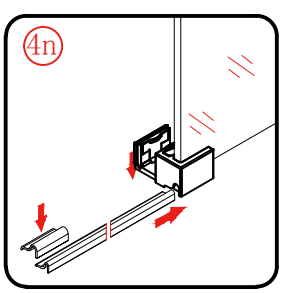
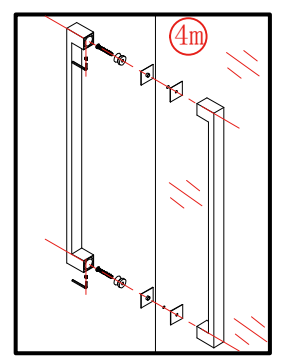
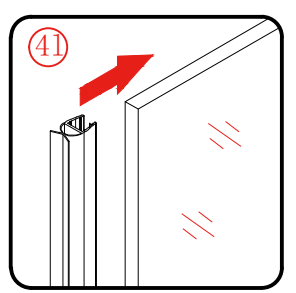

6

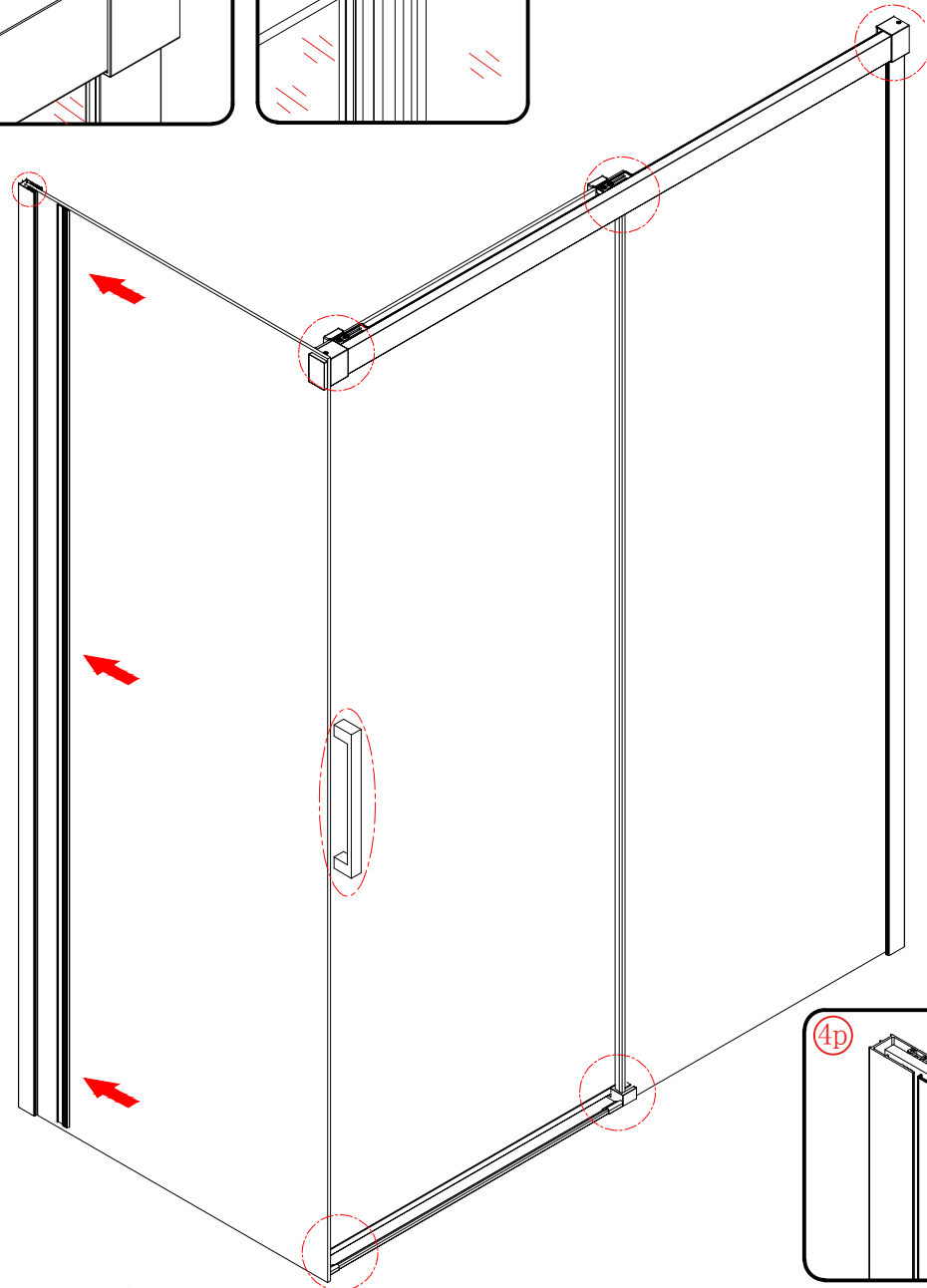

"Dit product is zwaar en vereist 2 personen voor installatie"



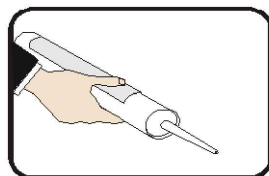
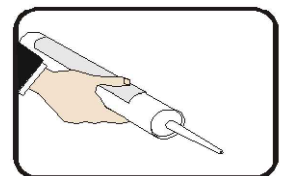
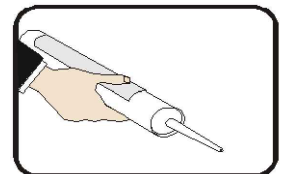
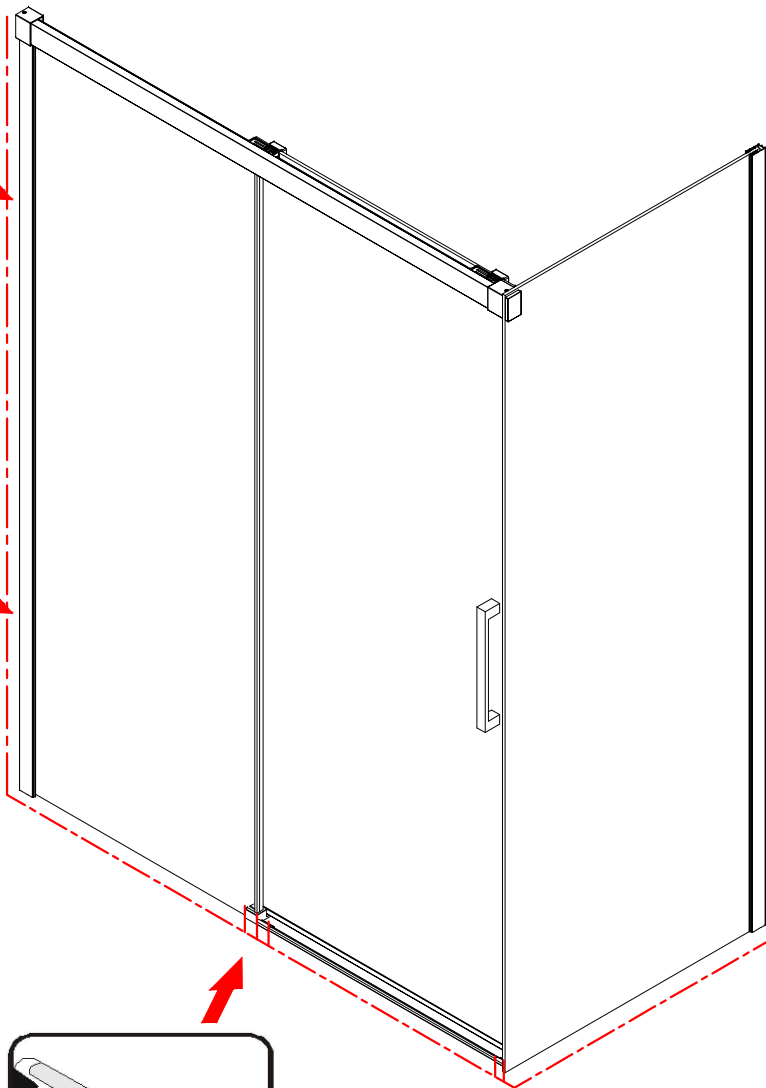
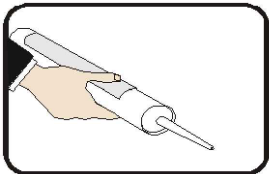
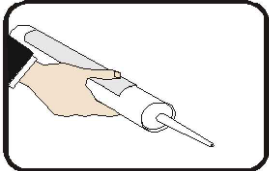
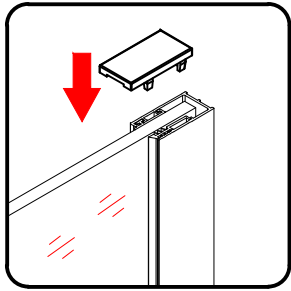

Let op! De douchecabine dient uitsluitend aan de buitenzijde afgekit te worden. Dit zodat het water wat tijdens het douchen tussen de profielen komt weer terug de doucheruimte in stroomt. Afkitten aan de binnenzijde zal lekkage veroorzaken. Gebruik voor het afdichten van de douche uitsluitend sanitairkit. Nadat de douchecabine is afgekit dient deze 24 uur niet gebruikt te worden, dit zodat de sanitairkit goed is uitgehard.



"Dit product is zwaar en vereist 2 personen voor installatie"



OF

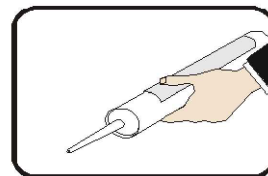
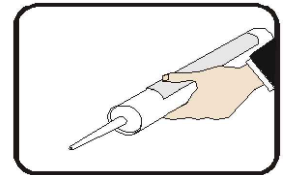
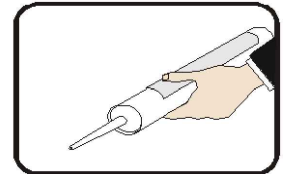
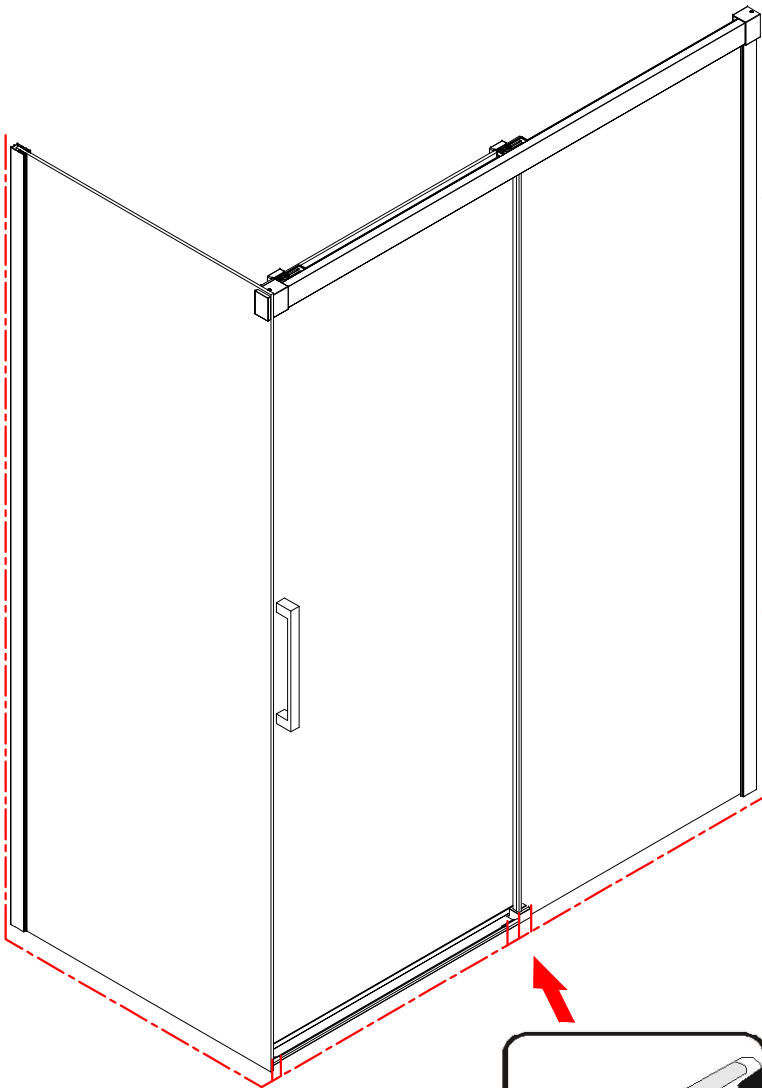
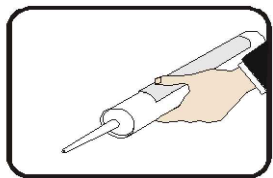
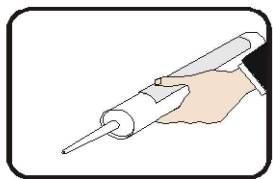
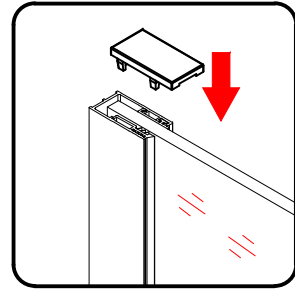

7

Let op! De douchecabine dient uitsluitend aan de buitenzijde afgekit te worden. Dit zodat het water wat tijdens het douchen tussen de profielen komt weer terug de doucheruimte in stroomt. Afkitten aan de binnenzijde zal lekkage veroorzaken. Gebruik voor het afdichten van de douche uitsluitend sanitairkit. Nadat de douchecabine is afgekit dient deze 24 uur niet gebruikt te worden, dit zodat de sanitairkit goed is uitgehard.



"Dit product is zwaar en vereist 2 personen voor installatie"



VEILIGHEIDSVOORSCHRIFTEN

Plaats de glasplaten rechtop tegen de muur. Zorg ervoor dat de glaswanden tijdens het uitpakken niet koud op een harde ondergrond worden gezet, maar dat deze ondersteund worden door karton of een ander zacht materiaal. Leg de glasplaten niet plat op de grond, hierdoor kunnen krassen en breuk ontstaan. Transporteer de glasplaten uitsluitend in verticale richting.

Siliconen afdichtingsproducten en strippen kunnen door een combinatie van water, lucht en reinigingsmiddelen verkleuren met schimmelvorming als gevolg. Wij adviseren dan ook om uw douche na ieder gebruik droog te maken en de badkamer geregeld te laten ventileren. Kalkaanslag geeft geen recht op retourname of het verlagen van de aankoopprijs. Dit omdat het een onderhoudsgerelateerde klacht is.

Na installatie van uw douchescherm dient u de siliconenkit tenminste 24 uur te laten uitharden. Hierna kunt u uw nieuwe douchescherm met zachte middelen reinigen.

REINIGING EN ONDERHOUD





LET OP! BIJ ENKELZIJDIGE GLASBEHANDELING MOET DE STICKER "EASY CLEAN" AAN DE BUITENZIJDIGE WORDEN GEPLAATST.

Proficiat met uw ROWE douchescherm, ROWE doucheschermen staan voor jarenlang doucheplezier.

Om het onderhoud te vergemakkelijken hebben wij uw douchescherm voorzien van een Nano-Flow glasbehandeling. De Nano-Flow glasbehandeling is een speciale laag die het glas een extra glad oppervlak geeft. Hierdoor heeft vuil en kalk minder kans om te hechten. Het water parelt als het ware van het glas.

Reiniging is toch geboden, maar door de geringe aanpak is deze sneller te reinigen en spaart u weer tijd. Zo wordt uw douchescherm gemakkelijk te onderhouden en glanzend schoon.

Denk eens aan het milieu, minder gebruik van schoonmaakmiddel door de Nano-Flow oppervlakbehandeling spaart het milieu en oppervlaktewater.

| Reinigingswijze | | | | Aanbevolen reinigingsinterval |
|--------------------------|--|---|--|--|
| Routine reiniging |  Met helder heet water en aansluitend koud water afspoelen |  Drogen | | Direct na het douchen |
| Hoofd reiniging |  Met verdund schoonmaak- azijn reinigen |  Met helder water afspoelen |  Drogen | Naar gebruiksfrequentie wekelijks of maandelijks |

De juiste reiniging is belangrijk

Uw douchescherm is onderhoudsvriendelijk geconstrueerd. Door profielen waar het water gemakkelijk afloopt en vlakke-, gladde glasdelen aan de binnenzijde. Om uw douchescherm lang glanzend te houden dient u enige regels in acht te nemen: profielen en glasdelen mogen uitsluitend met milde, in de handel verkrijgbare zachte reinigingsmiddelen gereinigd te worden. In geen geval poets- of schuurmiddelen, alcohol, nitro of nitroverdunding, ammonia of reinigingsmiddelen met week-, oplosmiddelen gebruiken!

Beslissend is de regelmatige reiniging, Niet verwijdert vuil, kalk etc. zet over elkaar sterker aan en schoonmaken wordt daardoor steeds moeilijker. Tip is om na iedere douchebeurt eerst met heet en daarna met koud water het glas af te spoelen en aansluitend afdrogen met bijvoorbeeld uw gebruikte handdoek of raamwisser.