

ISTRUZIONI DI MONTAGGIO

FITTING INSTRUCTION

NOTICE DE POSE

NEP3



LEGGERE ATTENTAMENTE IL PRESENTE MANUALE

PDP Box Doccia declina ogni responsabilità per eventuali problemi dovuti ad un montaggio non conforme alle indicazioni qui riportate e non eseguito a regola d'arte o da personale non qualificato. PDP Box Doccia si riserva il diritto di apportare modifiche ai propri prodotti senza preavviso e senza aggiornare tempestivamente la relativa documentazione.

READ CAREFULLY

The manufacturer cannot be responsible for any damages caused by a non-proper fitting of the shower enclosure. In this respect, PDP recommends its products to be installed by qualified personnel. Our policy of reviewing product development means that PDP Box Doccia may change product specifications without notice.

A LIRE AVEC ATTENTION

Afin de garantir un bon fonctionnement, le montage doit être effectué par un installateur professionnel. Le fabricant ne sera pas responsable des conséquences résultant d'une pose non effectuée dans les règles de l'art. PDP Box Doccia se réserve le droit d'apporter à tout moment des modifications à ses produits sans préavis et sans mettre au-jour immédiatement la documentation.

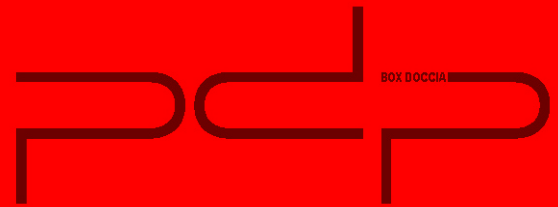

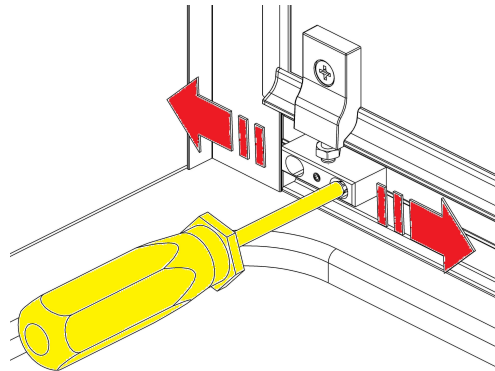
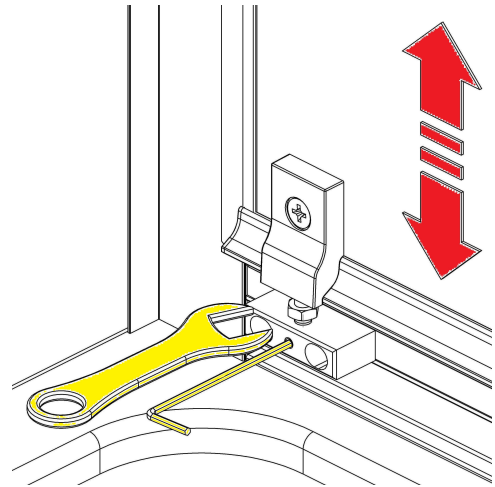
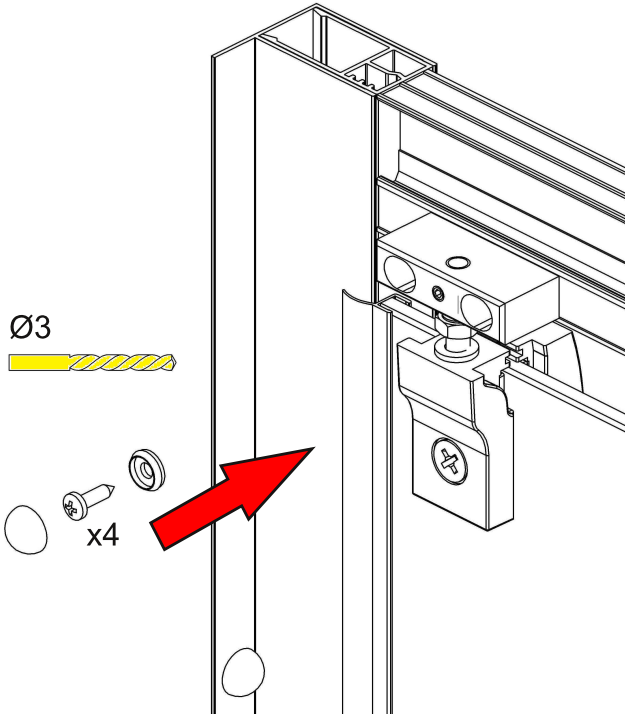
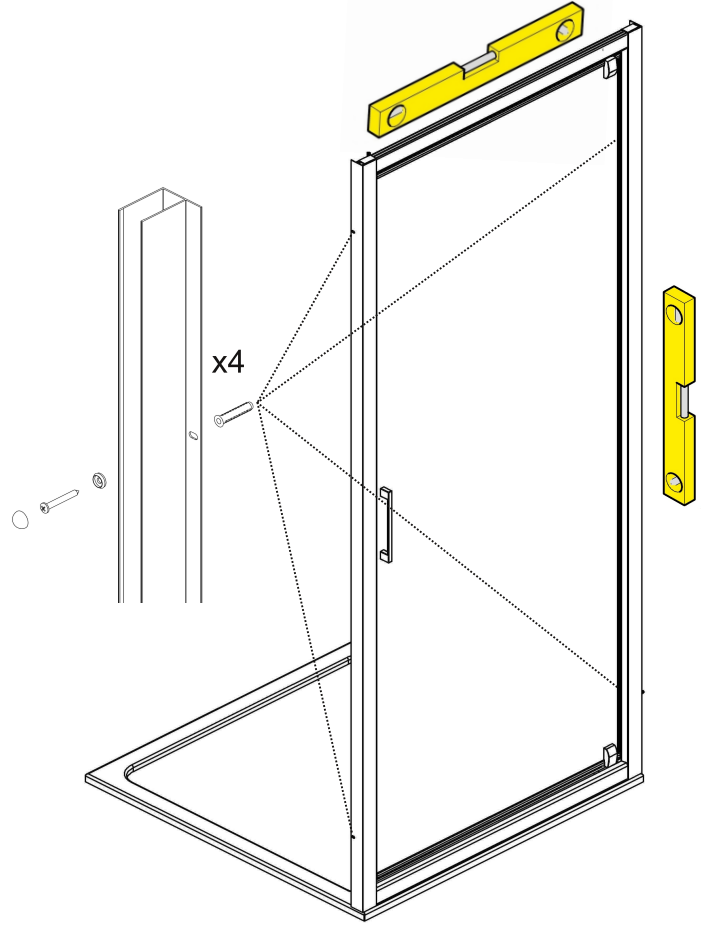
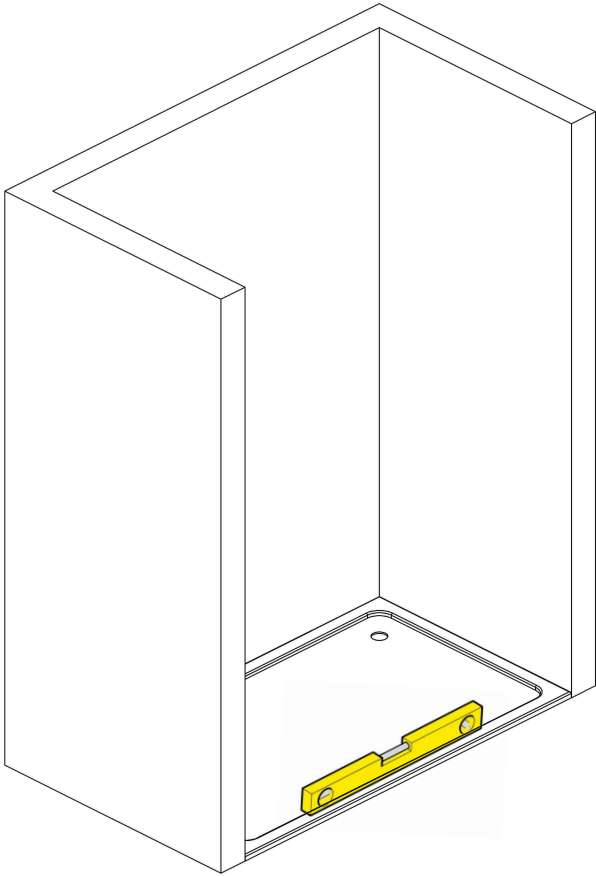

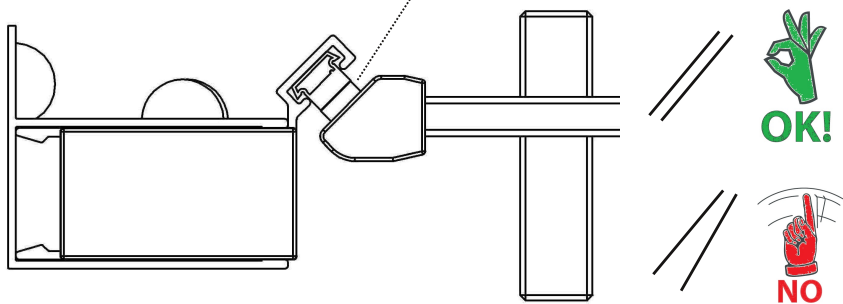
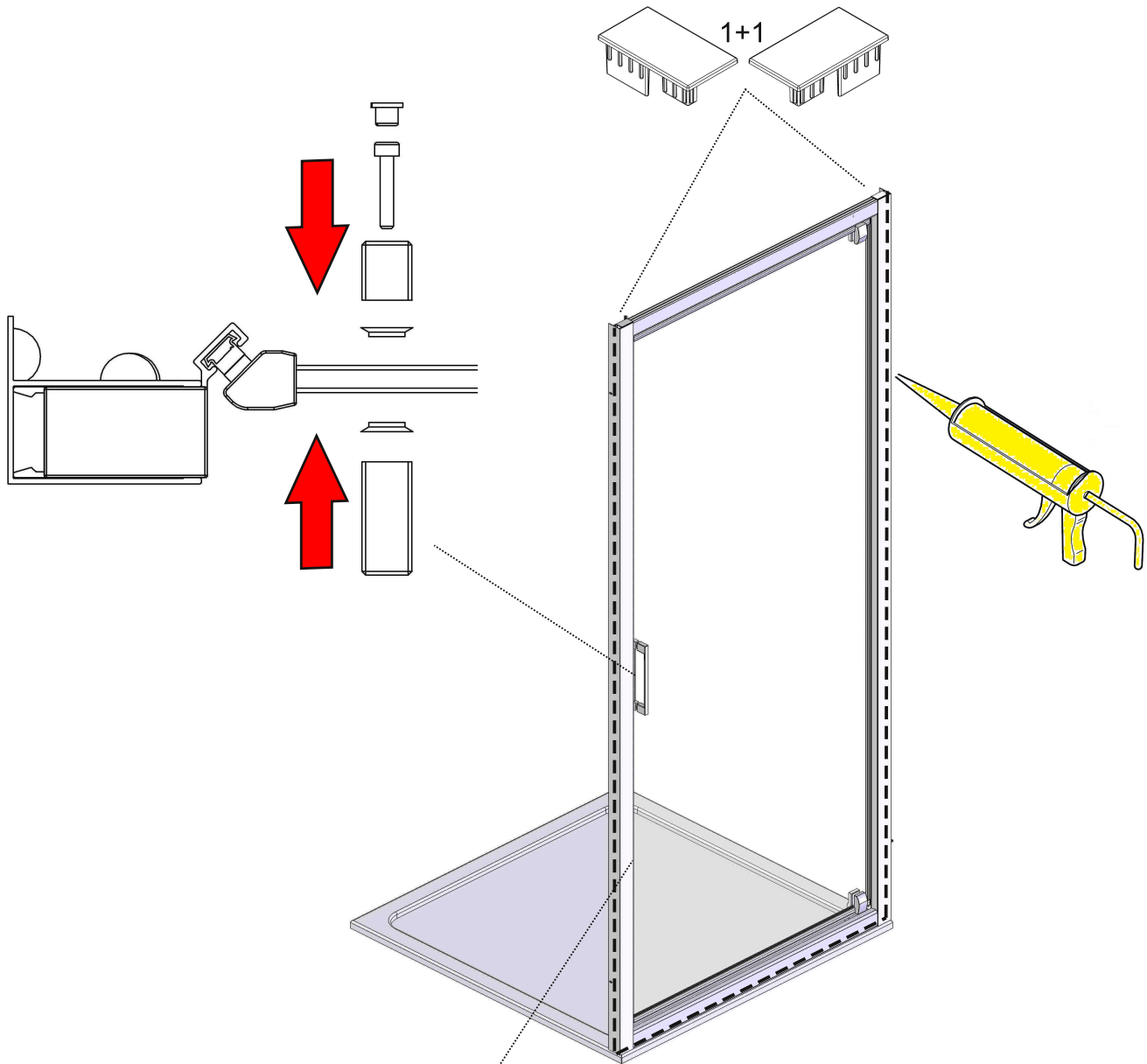

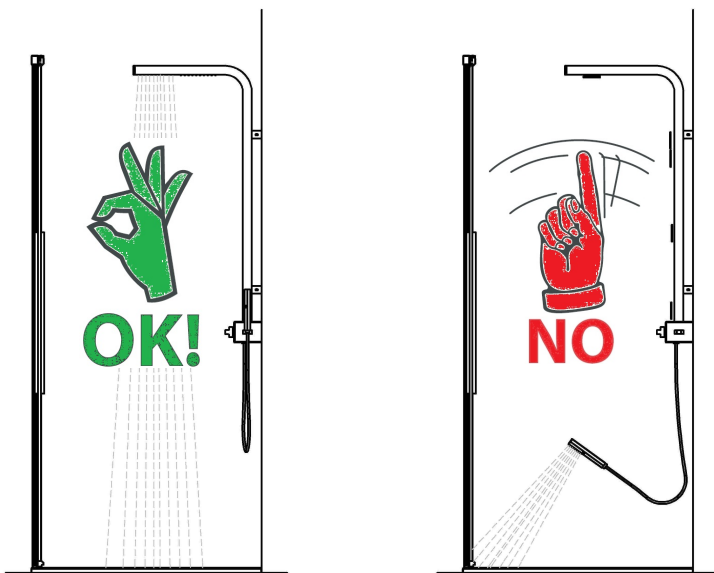

IT - L'USO APPROPRIATO DEL VOSTRO BOX DOCCIA GARANTISCE LA CORRETTA TENUTA D'ACQUA.

EN - THE PROPER USE OF YOUR SHOWER ENCLOSURE GUARANTEES ITS FUNCTIONALITY AND THE WATER TIGHTNESS.

FR - L'EMPLOI CORRECT DE VOTRE PAROI DOUCHE GARANTIT UNE BONNE FONCTIONNALITE ET ETANCHEITE.

NOTE IMPORTANTI

L'installazione e la sigillatura del box doccia devono essere eseguiti da personale qualificato.

Prima di iniziare il montaggio, controllare se il prodotto ha subito danni durante il trasporto. Eventuali reclami su prodotti già installati non saranno accettati

Il materiale di fissaggio fornito, tasselli e viti, è adatto a muri in cemento e/o laterizio. Per pareti realizzate in materiali diversi, per es. cartongesso, si devono utilizzare sistemi di fissaggio specifici.

Per la sigillatura utilizzare solo silicone o altro prodotto sigillante idoneo alle superfici sulle quali viene fissato il box doccia.

Prima di usare il box doccia lasciare indurire il silicone per almeno 24 ore.

Per pulire la vostra cabina doccia dovete usare solo un panno morbido. Non usate mai detersivi, solventi o materiali abrasivi, perché potrebbero deteriorare le superfici lucide e verniciate.

IMPORTANT ADVICES

PDP recommends your shower enclosure to be fitted and sealed by qualified operators.

Before starting the fitting operations, please check carefully if your shower enclosure has been damaged during transport. PDP will not accept complaints on products which have already been fitted.

The fixing kits provided with a PDP shower cabin are suitable for cement and/or brick walls. For walls raised with other kinds of materials (i.e. wallboard), proper fixing elements should be used.

For sealing, please use silicon only or, as alternative, some sealing products suitable for the surfaces where you shower enclosure has to be fitted.

Before using the shower enclosure, let the silicon dry for at least 24 hours

To clean your shower enclosure, please use a soft cloth only. Never use detergents, solvents, or abrasive materials, as they could damage the polished and varnished surfaces.

RECOMMANDATIONS IMPORTANTES

Nous vous recommandons de faire installer et silicuner votre parois douche PDP par des opérateurs qualifiés.

Avant de l'installer, bien contrôler que votre parois douche n'ait pas subi des damages pendant le transport. PDP n'acceptera pas de réclamations si la cabine a déjà été installée.

Les outils (vis et quincaillerie) donnés avec votre parois douche PDP sont appropriés pour la fixation au murs en ciment et/ou en brique. On recommande d'utiliser de la visserie appropriée si vous avez des murs en matériaux différents (ex. placoplâtre).

Silicuner en utilisant seulement du silicone ou un produit similaire qui soit propre aux surfaces où votre parois douche doit être installée.

Laisser sécher le silicone pour 24 heures au moins avant d'utiliser votre parois douche .

Pour nettoyer votre cabine douche, vous devez employer seulement un chiffon moelleux. N'employez jamais des détergents ou des matériaux abrasif, parce-qu'ils pourraient détériorer la surface polie e vernie.

PDP Box Doccia S.p.a. con socio unico
Via Ponzimiglio Z.I., 44 - 36047 Montegalda (VI) ITALY
Tel. +39 0444 736736 - Fax. +39 0444 737180
info@pdpboxdoccia.com - www.pdpboxdoccia.com

ASSISTENZA POST VENDITA: assistenzatecnica@pdpboxdoccia.com +39 366 7121740

SERVIZIO RICAMBI: ricambi@pdpboxdoccia.com