

ELISE

Nisdeur

Montage voorschrift

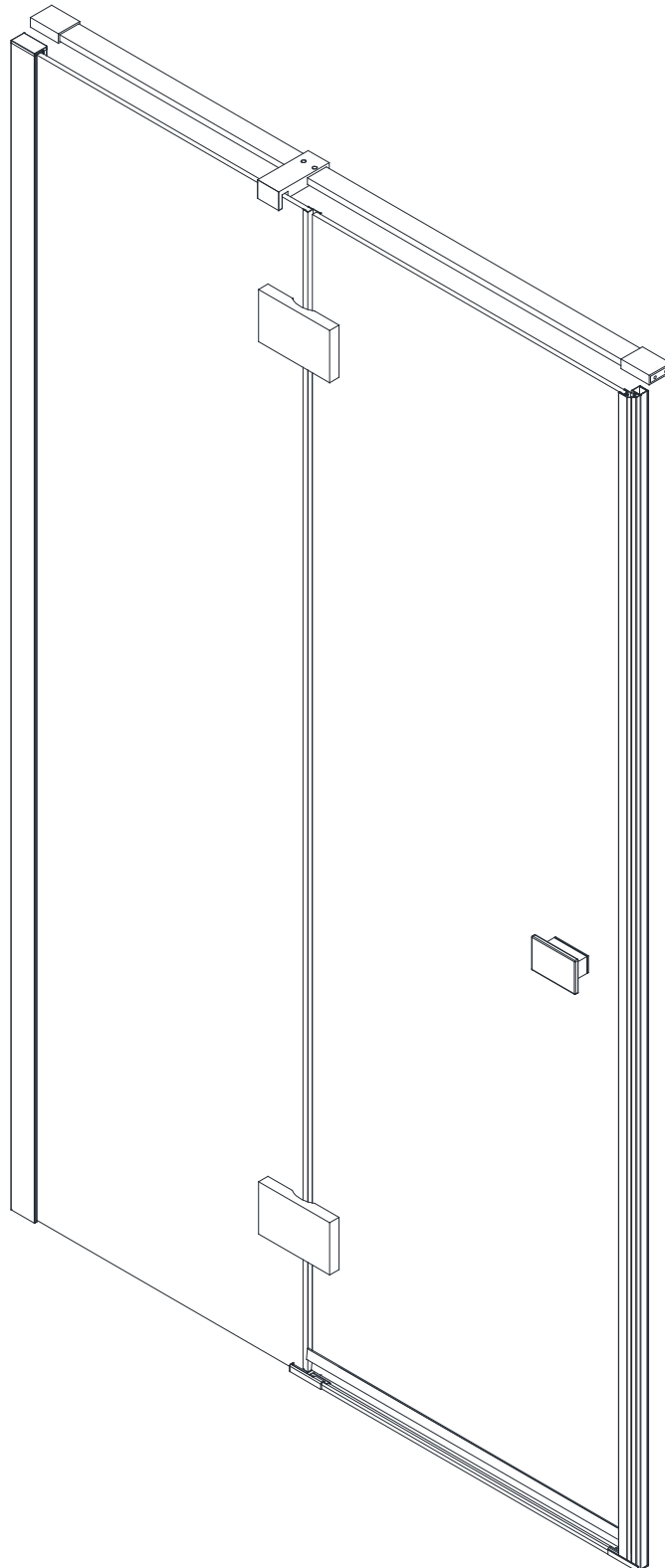

HANDLEIDING

Lees deze handleiding goed door voor u met de installatie begint.

1. Overtuig u ervan dat u het benodigde gereedschap heeft
2. Controleer dat de plaats voor installatie geschikt is voor de MAATVOERING
3. Controleer alle onderdelen van de douchecabine
4. Overtuig u ervan dat de montageset compleet is
5. Controleer indien de cabine op een douchebak komt, dat deze aan alle zijden waterpas staat, En dat deze voor installatie aan de muurzijden volledig en goed is afgekit

Indien er onderdelen beschadigd zijn of ontbreken, dient u uw leverancier binnen 2 dagen na de datum van aankoop daarvan in kennis te stellen. Probeer NIET het artikel te installeren zonder eerst de hierboven aangegeven 5 punten in acht te hebben genomen **NA INSTALLATIE KUNT U NIET MEER RECLAMEREN**

De muurpluggen die met de montageset meegeleverd worden, mogen alleen op stevige wanden gebruikt worden. Bij "scheidingswanden" dient u een ander bevestigingsmethode toe te passen. Wendt u tot een ijzerhandel voor verdere informatie over de juiste bevestigingsmethode. Soms is het voor de juiste boormethode noodzakelijk het advies van een tegelhandel in te winnen.

LET OP! Gebruik altijd roestvrijstalen schroeven.

BENODIGDHEDEN

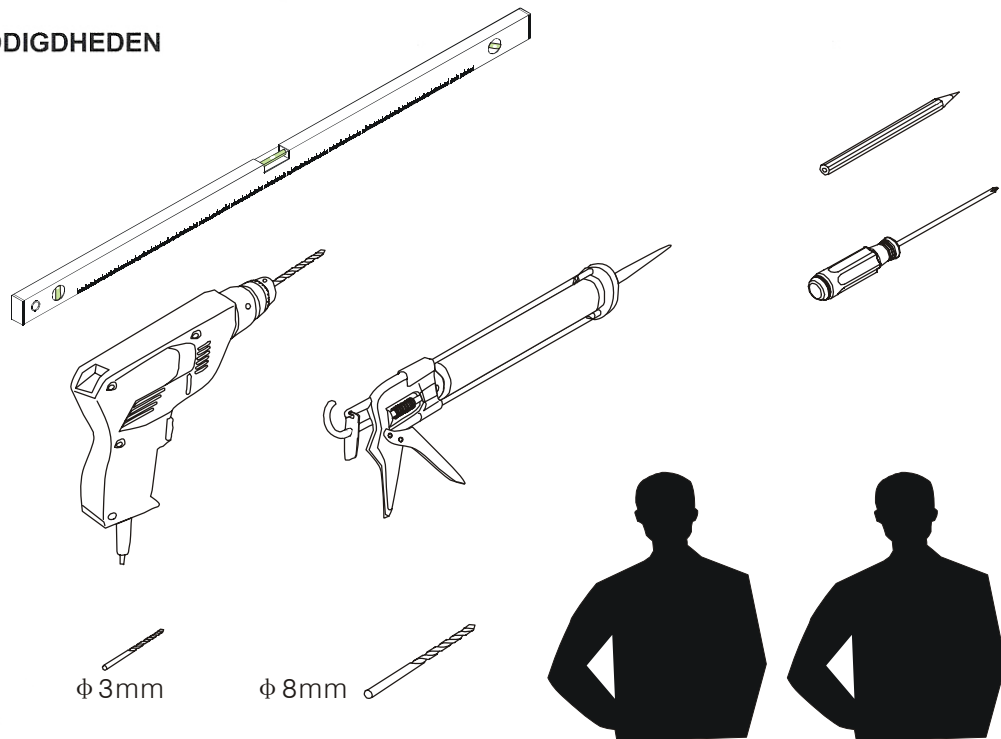

BELANGRIJKE INSTRUCTIES VOOR DE KLANT

Voor het schoonmaken van uw douchecabine moet u alleen een zachte doek gebruiken. Gebruik nooit oplos-, was-, en schuurmiddelen, omdat deze de glanzende chroomlaag zouden kunnen beschadigen.

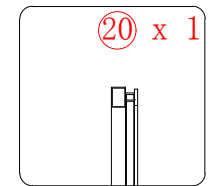
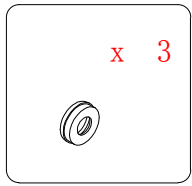
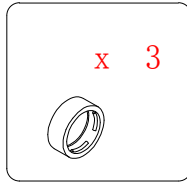
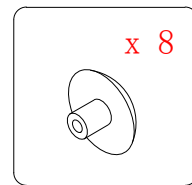
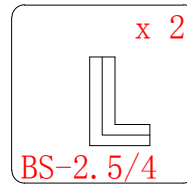
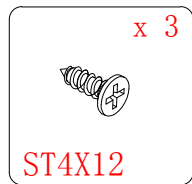
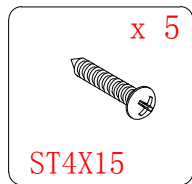
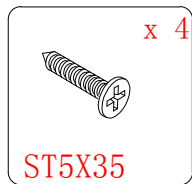
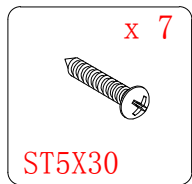
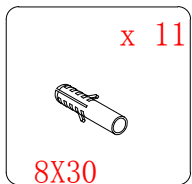
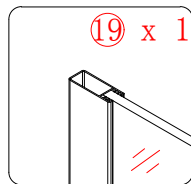
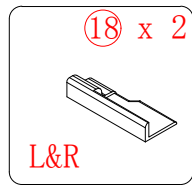
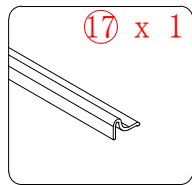
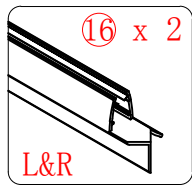
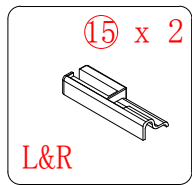
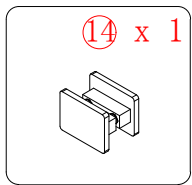
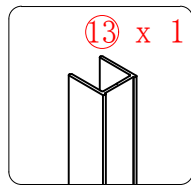
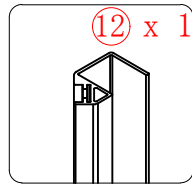
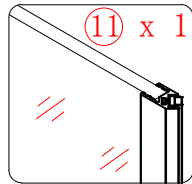
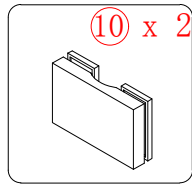
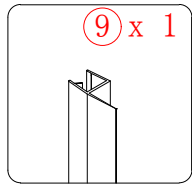
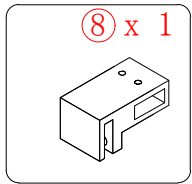
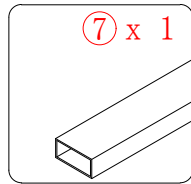
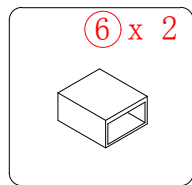
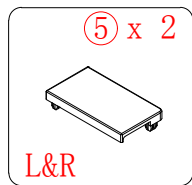
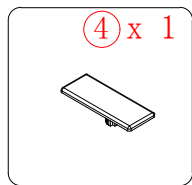
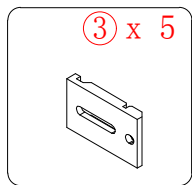
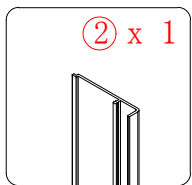
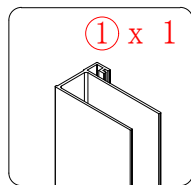
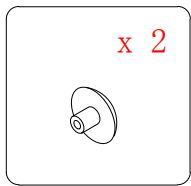
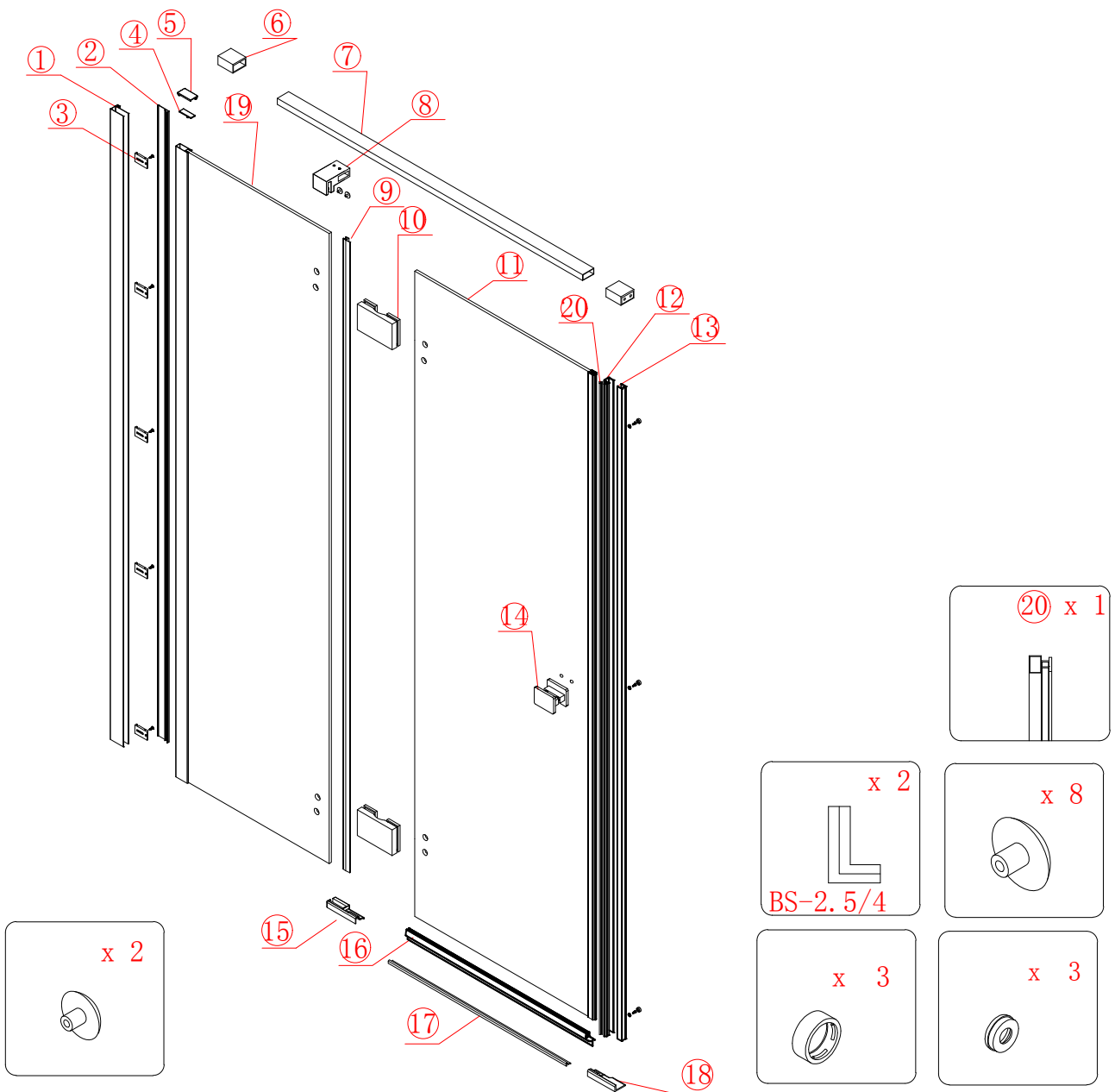

"Dit product is zwaar en vereist 2 personen voor installatie"



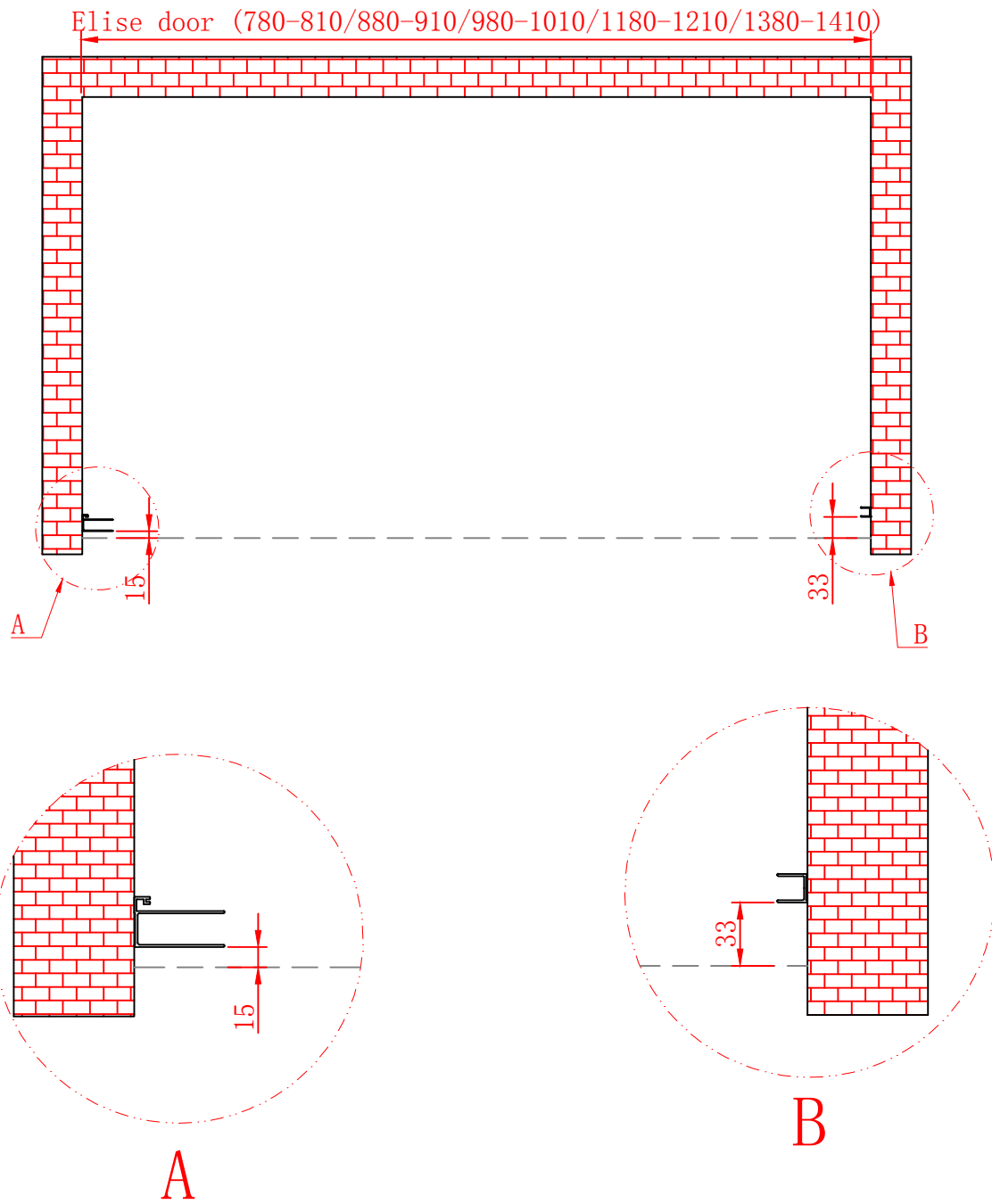



"Dit product is zwaar en vereist 2 personen voor installatie"

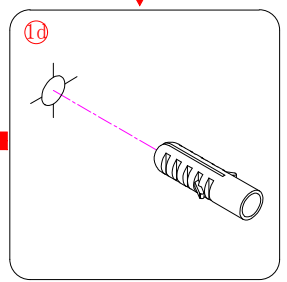
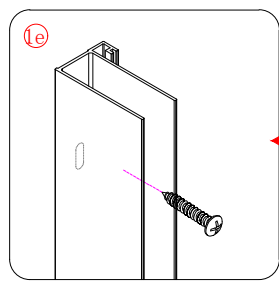
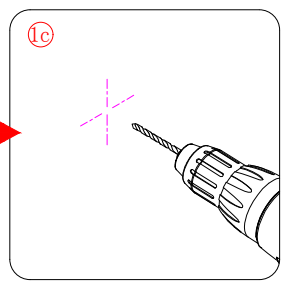
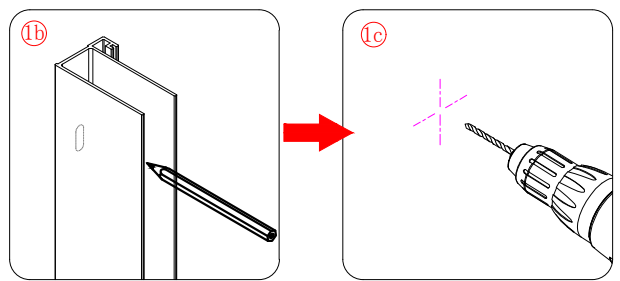
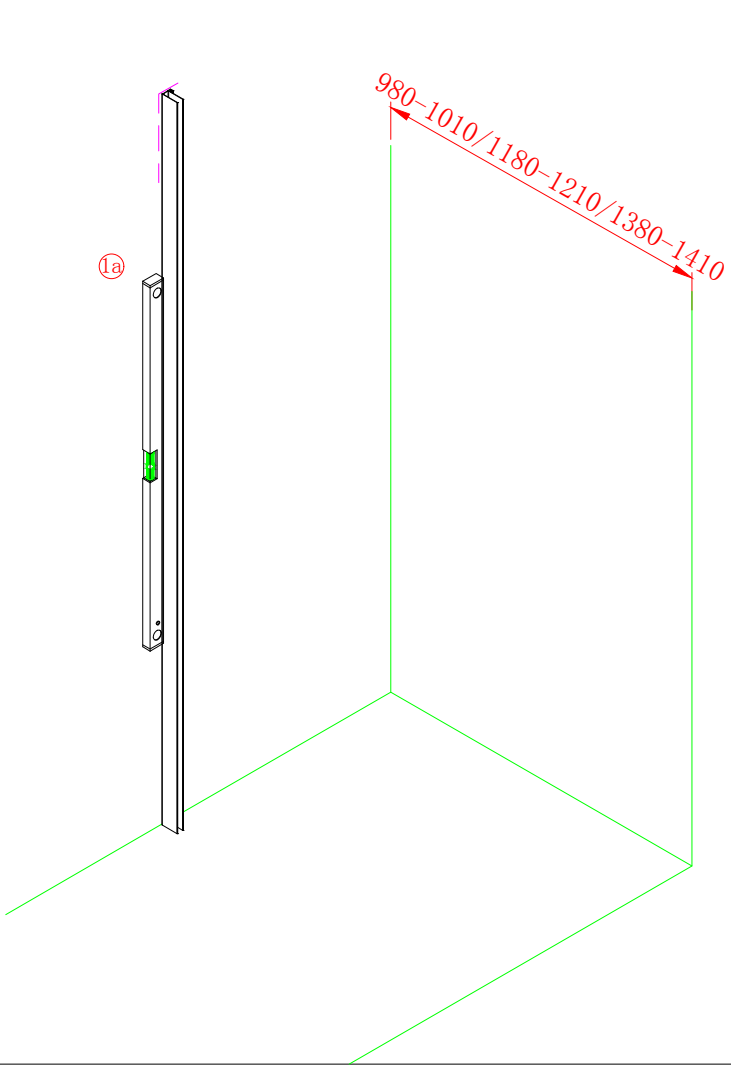

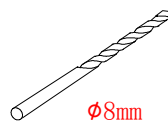
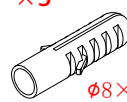

- 
 $\phi 8\text{mm}$
- $\times 3$

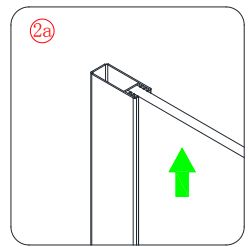
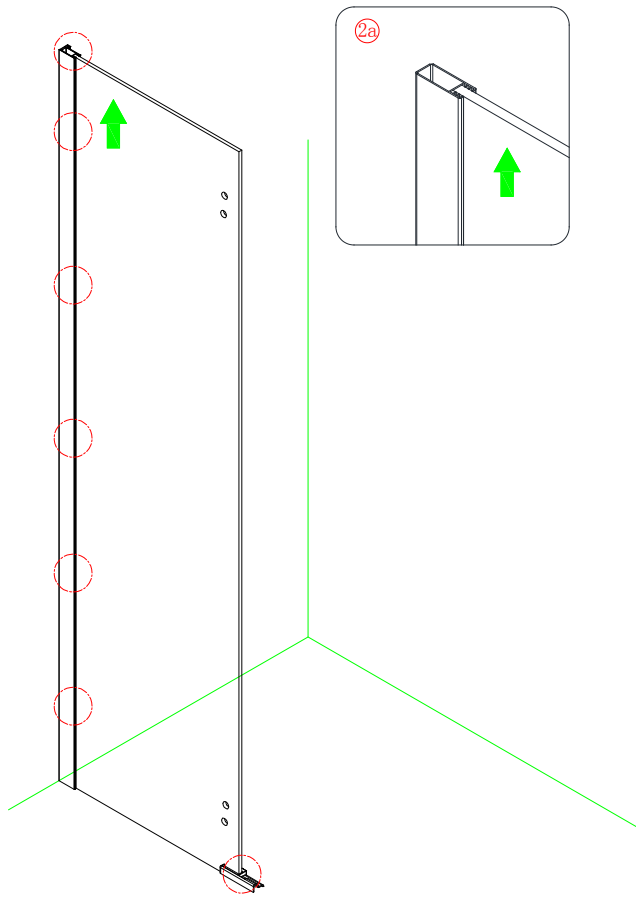
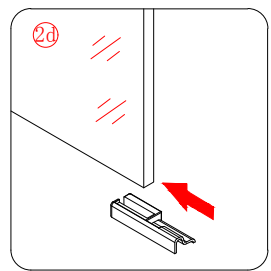
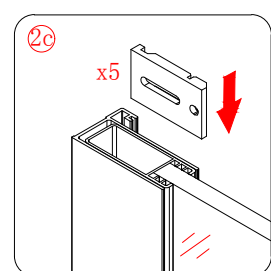
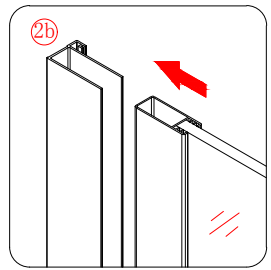
 $\phi 8 \times 30$
- $\times 3$

 ST5X30

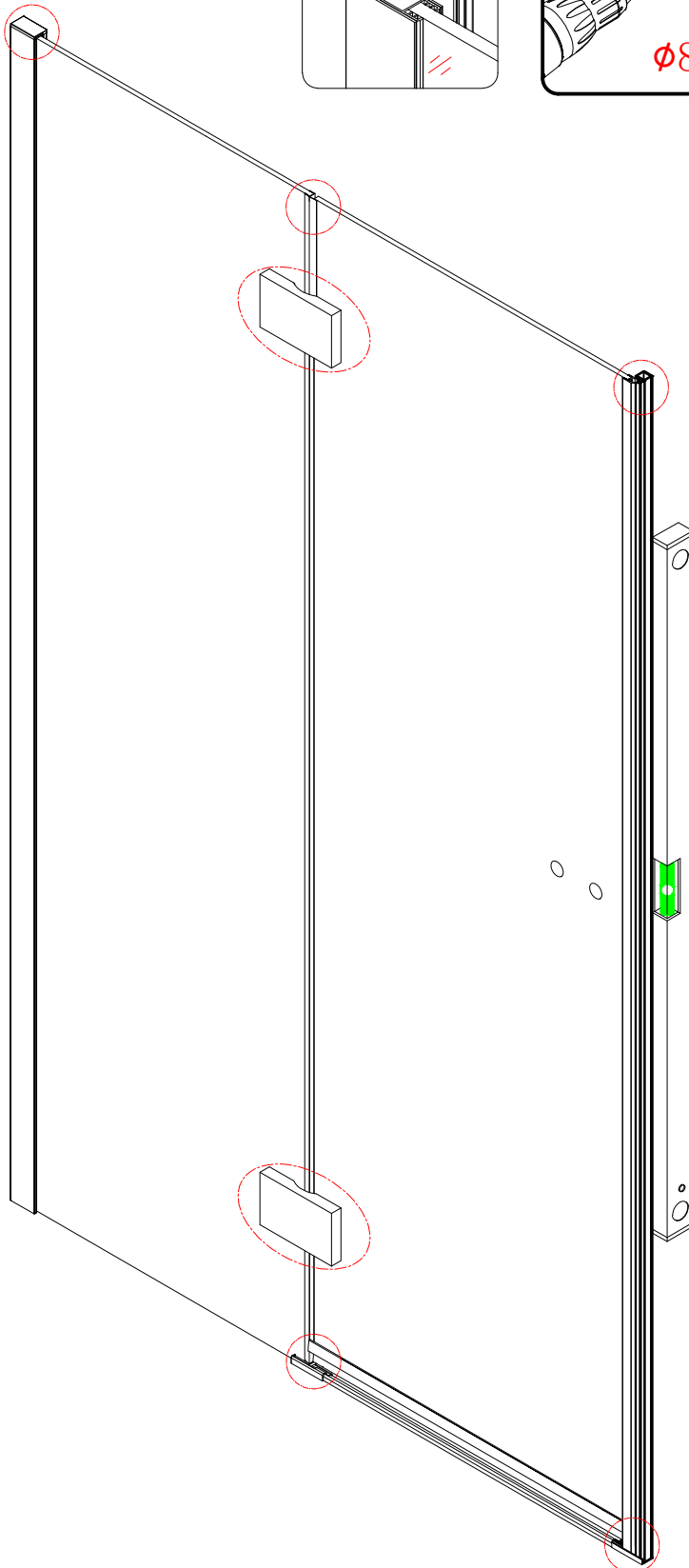
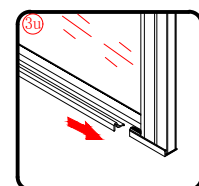
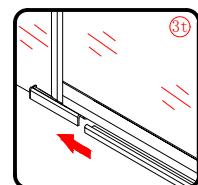
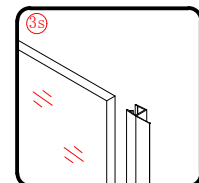
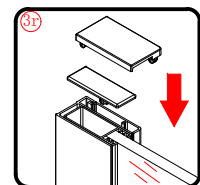
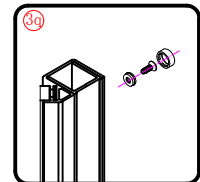
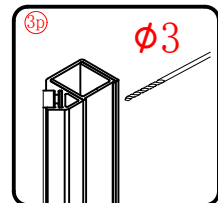
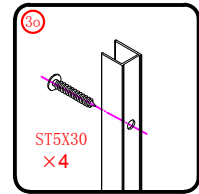
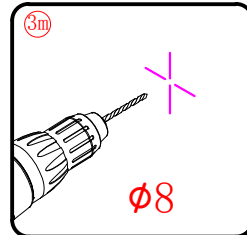
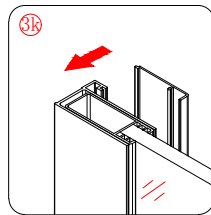
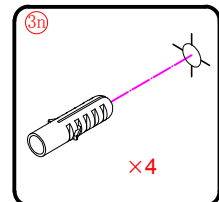
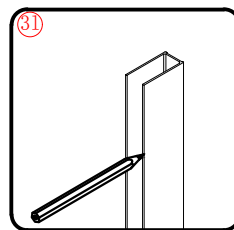
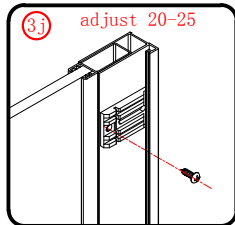
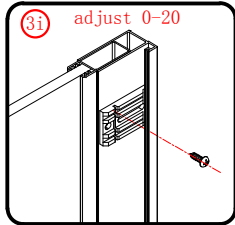
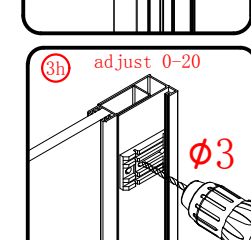
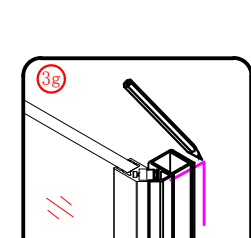
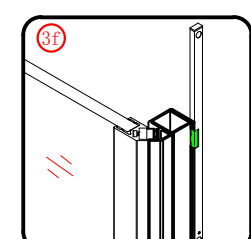
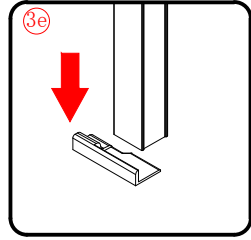
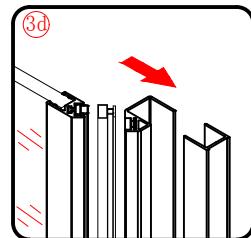
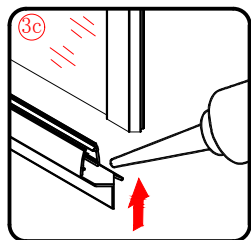
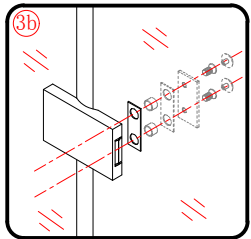
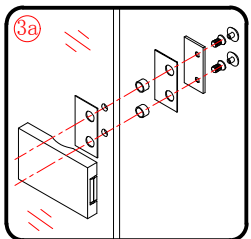

"Dit product is zwaar en vereist 2 personen voor installatie"





"Dit product is zwaar en vereist 2 personen voor installatie"



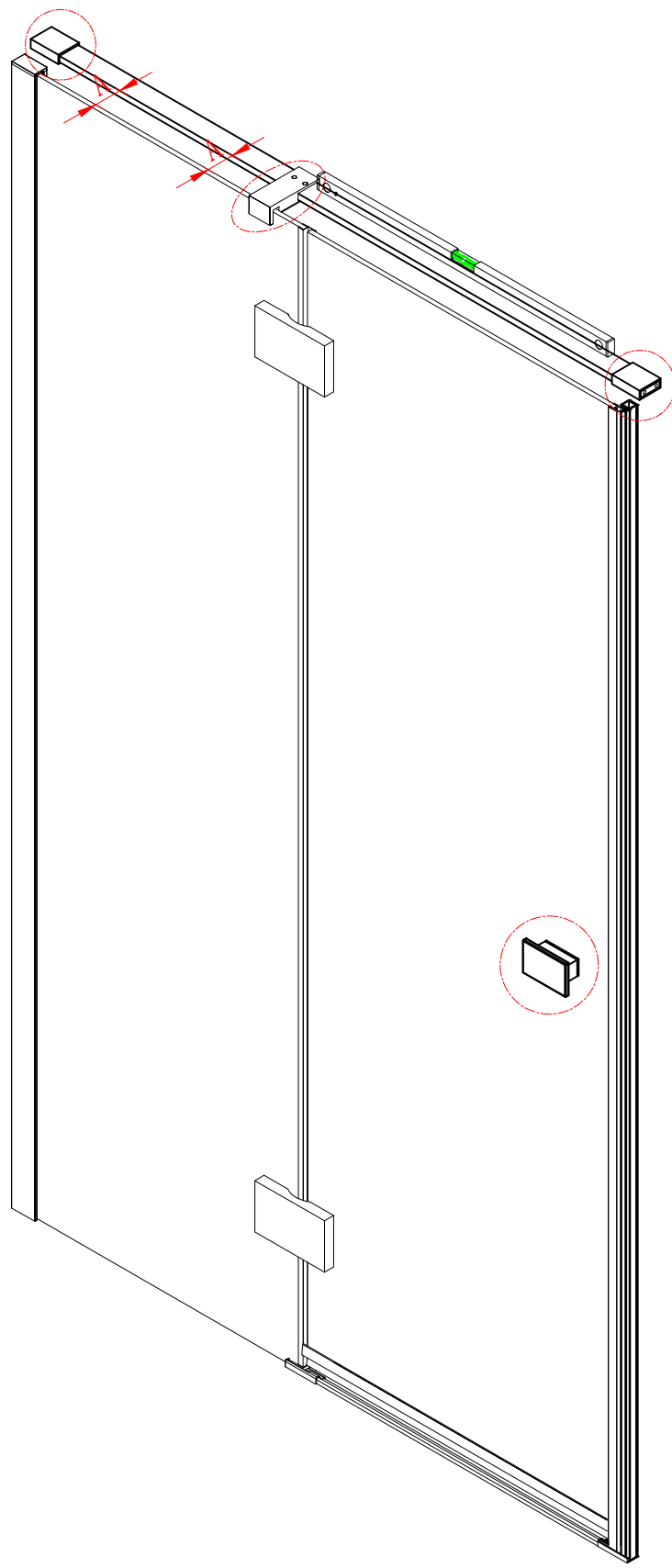
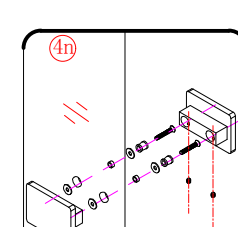
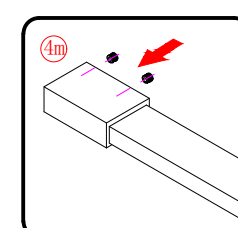
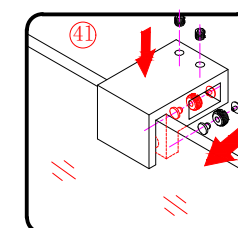
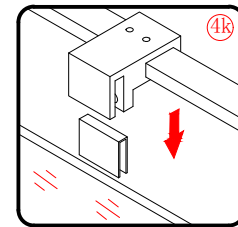
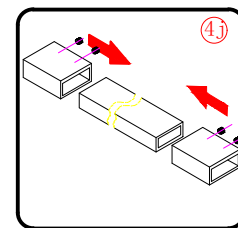
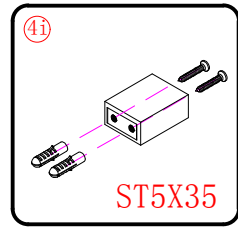
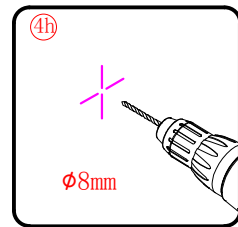
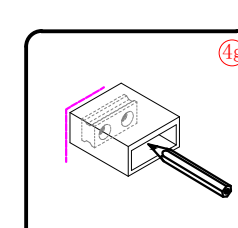
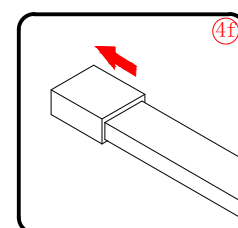
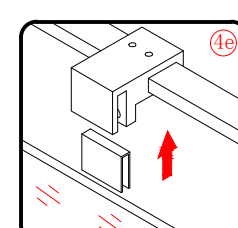
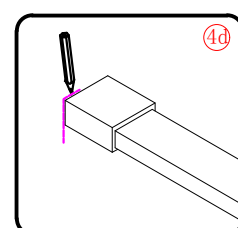
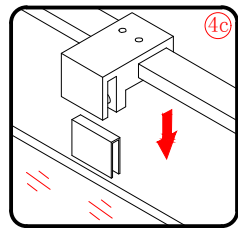
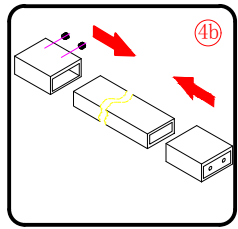
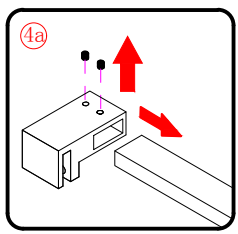

"Dit product is zwaar en vereist 2 personen voor installatie"



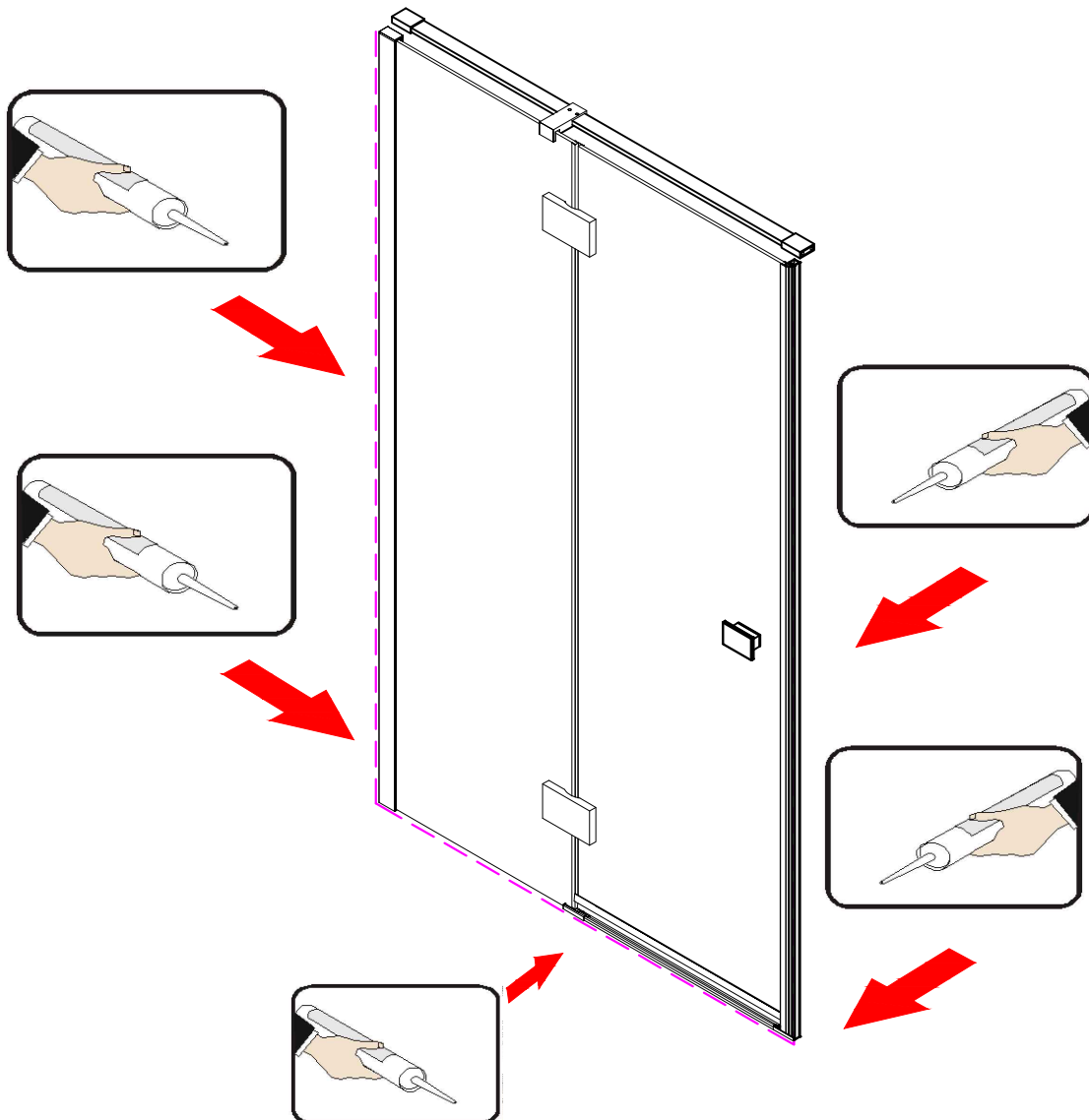

Let op! De douchecabine dient uitsluitend aan de buitenzijde afgekit te worden. Dit zodat het water wat tijdens het douchen tussen de profielen komt weer terug de doucheruimte in stroomt. Afkitten aan de binnenzijde zal lekkage veroorzaken. Gebruik voor het afdichten van de douche uitsluitend sanitairkit. Nadat de douchecabine is afgekit dient deze 24 uur niet gebruikt te worden, dit zodat de sanitairkit goed is uitgehard.



"Dit product is zwaar en vereist 2 personen voor installatie"

